

Title	Common Developments of Several Different Orthogonal Boxes
Author(s)	Abel, Zachary; Demaine, Erik; Demaine, Martin; Matsui, Hiroaki; Rote, Günter; Uehara, Ryuhei
Citation	The 23rd Canadian Conference on Computational Geometry (CCCG' 11): 77-82
Issue Date	2011
Type	Conference Paper
Text version	author
URL	<a href="http://hdl.handle.net/10119/10308">http://hdl.handle.net/10119/10308</a>
Rights	Copyrights of the article is maintained by the authors. Zachary Abel, Erik Demaine, Martin Demaine, Hiroaki Matsui, Günter Rote and Ryuhei Uehara, The 23rd Canadian Conference on Computational Geometry (CCCG' 11), 2011, pp.77-82.
Description	

# Common Developments of Several Different Orthogonal Boxes

Zachary Abel\*   Erik Demaine†   Martin Demaine‡   Hiroaki Matsui§   Günter Rote¶   Ryuhei Uehara||

## Abstract

We investigate the problem of finding common developments that fold to plural incongruent orthogonal boxes. It was shown that there are infinitely many orthogonal polygons that fold to two incongruent orthogonal boxes in 2008. In this paper, we first show that there is an orthogonal polygon that fold to three boxes of size  $1 \times 1 \times 5$ ,  $1 \times 2 \times 3$ , and  $0 \times 1 \times 11$ . Although we have to admit a box to have volume 0, this solves the open problem mentioned in literature. Moreover, once we admit that a box can be of volume 0, a long rectangular strip can be folded to an arbitrary number of boxes of volume 0. We next consider for finding common non-orthogonal developments that fold to plural incongruent orthogonal boxes. In literature, only orthogonal folding lines or with 45 degree lines were considered. In this paper, we show some polygons that can fold to two incongruent orthogonal boxes in more general directions.

## 1 Introduction

Since Lubiw and O’Rourke posed the problem in 1996 [4], polygons that can fold to a (convex) polyhedron have been investigated. In a book about geometric folding algorithms by Demaine and O’Rourke in 2007, many results about such polygons are given [3, Chapter 25]. Such polygons have an application in the form of toys and puzzles. For example, the puzzle “cubigami” (Figure 1) is developed by Miller and Knuth, and it is a common development of all tetracubes except one (of surface area 16). One of the many interesting problems in this area is that whether there exists a polygon that folds to plural incongruent orthogonal boxes. Biedl et al. answered “yes” by finding two polygons that fold to two incongruent orthogonal boxes [2] (see also [3, Figure



Figure 1: Cubigami.

25.53]). Later, Mitani and Uehara constructed infinite families of orthogonal polygons that fold to two incongruent orthogonal boxes [5]. However, it is open that whether there is a polygon that can fold to three or more boxes.

First, we give an affirmative answer to this open problem, at least in some weak sense. That is, we give a polygon that can fold to three incongruent orthogonal boxes of size  $0 \times 1 \times 11$ ,  $1 \times 1 \times 5$ , and  $1 \times 2 \times 3$ . Note that one of the boxes is degenerate, as it has a side of length 0. Such a box is sometimes called a “doubly covered rectangle” (e.g., [1]). For boxes of positive volume, the existence of three boxes with a common unfolding is still open.

The polygon is found as a side effect of the enumeration of common developments of boxes of size  $1 \times 1 \times 5$  and  $1 \times 2 \times 3$ . In the previous result by Mitani and Uehara [5], they randomly generated common developments of these boxes, and they estimated the number of common developments of these boxes at around 7000. However, they overestimated it since their algorithm did not exclude some symmetric cases. We enumerate all common developments of boxes of size  $1 \times 1 \times 5$  and  $1 \times 2 \times 3$ , which can be found on a Web page<sup>1</sup>. As a result, the number of common developments of these boxes is 2263. Among 2263 developments, the development in Figure 2 is the only one that can fold to  $0 \times 1 \times 11$ .

Once we admit that a box can be a doubly covered

\*Department of Mathematics, Massachusetts Institute of Technology, MA 02139, USA. [zabel@math.mit.edu](mailto:zabel@math.mit.edu)

†Computer Science and Artificial Intelligence Lab, Massachusetts Institute of Technology, MA 02139, USA. [edemaine@mit.edu](mailto:edemaine@mit.edu)

‡Computer Science and Artificial Intelligence Lab, Massachusetts Institute of Technology, MA 02139, USA. [mdemaine@mit.edu](mailto:mdemaine@mit.edu)

§School of Information Science, JAIST, Asahidai 1-1, Nomi, Ishikawa 923-1292, Japan. [s0910058@jaist.ac.jp](mailto:s0910058@jaist.ac.jp)

¶Institut für Informatik, Freie Universität Berlin, Takustraße 9, 14195 Berlin, Germany. [rote@inf.fu-berlin.de](mailto:rote@inf.fu-berlin.de)

||School of Information Science, JAIST, Asahidai 1-1, Nomi, Ishikawa 923-1292, Japan. [uehara@jaist.ac.jp](mailto:uehara@jaist.ac.jp)

<sup>1</sup><http://www.jaist.ac.jp/~uehara/etc/origami/net/all-22.html>

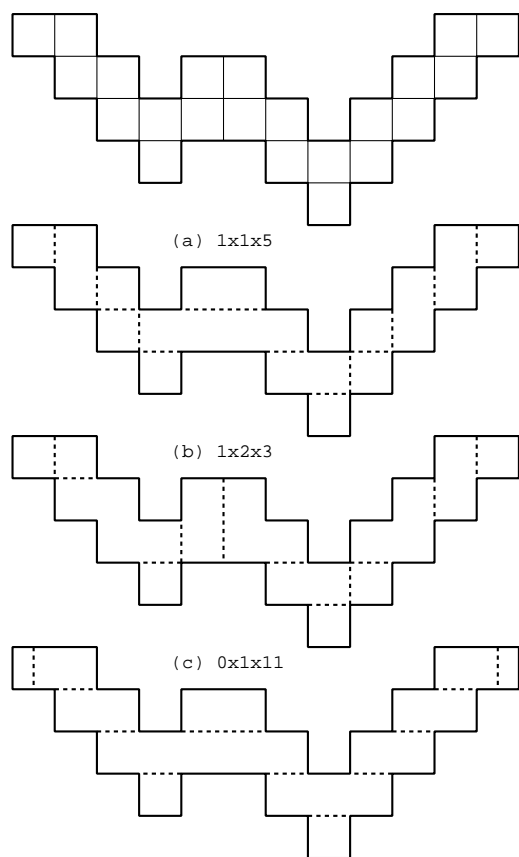

Figure 2: A common development of three different boxes. (a) Folding lines to make a  $1 \times 1 \times 5$  box. (b) Folding lines to make a  $1 \times 2 \times 3$  box. (c) Folding lines to make a  $0 \times 1 \times 11$  box.

rectangle, we have a new view of this problem since a doubly covered rectangle seems to be easier to construct than a box of positive volume. Indeed, we show that a sufficient long rectangular strip can be folded to an arbitrary number of doubly covered rectangles.

Next we turn to another approach to this topic. In an early draft by Biedl et al. [2], they showed a common development of two boxes of size  $1 \times 2 \times 4$  and  $\sqrt{2} \times \sqrt{2} \times 3\sqrt{2}$  (Figure 3). In the development, two folding ways to two boxes are not orthogonal. That is, the set of folding lines of a box intersect the other set of folding lines by 45 degrees. This development motivates us to the following problem: Is there any common development of two incongruent boxes such that two sets of folding lines intersect by an angle different from 45 or 90 degrees? We give an affirmative answer to this question.

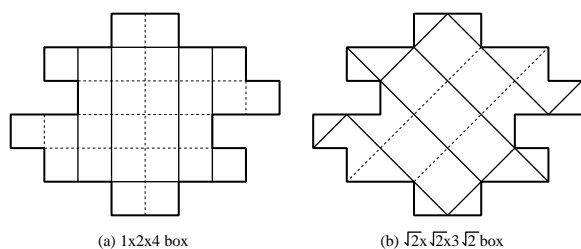

Figure 3: A common development of two different boxes by Biedl et al. [2]. (a) Folding lines to make a  $1 \times 2 \times 4$  box. (b) Folding lines to make a  $\sqrt{2} \times \sqrt{2} \times 3\sqrt{2}$  box.

## 2 Common orthogonal developments of boxes of size $1 \times 1 \times 5$ and $1 \times 2 \times 3$

For a positive integer  $S$ , we denote by  $P(S)$  the set of three integers  $a, b, c$  with  $0 < a \leq b \leq c$  and  $ab+bc+ca = S$ , i.e.,  $P(S) = \{(a, b, c) \mid ab+bc+ca = S\}$ . When we only consider the case that folding lines are on the edges of unit squares, it is necessary to satisfy  $|P(S)| \geq k$  to have a polygon of size  $2S$  that can fold to  $k$  incongruent orthogonal boxes of positive volumes. The smallest  $S$  with  $|P(S)| \geq 2$  is 11 and we have  $P(11) = \{(1, 1, 5), (1, 2, 3)\}$ . In this section, we concentrate at this special case. That is, we consider the developments that consist of 22 unit squares. Mitani and Uehara developed two randomized algorithms that try to find common developments of two different boxes [5]. Both algorithms essentially generate common developments randomly. Using the faster algorithm, they also estimated the number of common developments of the boxes of size  $1 \times 1 \times 5$  and  $1 \times 2 \times 3$  at around 7000. However, they overestimated it since their algorithm did not exclude some symmetric cases.

We develop another algorithm that tries all common developments of these boxes. For a common development  $P$  of the boxes, let  $P'$  be a connected subset of  $P$ . That is,  $P'$  be a set of unit squares and it produces a connected simple polygon. Then, clearly, we can stick  $P'$  on these two boxes without overlap. We use the term *common partial development* of the boxes to denote such a smaller polygon. For example, one unit square is the common partial development of the boxes of surface area 1, and a rectangle of size  $1 \times 2$  is the common development of them of surface area 2, and so on. Let  $L_i$  be the set of common partial developments of the boxes of surface area  $i$ . Then  $|L_1| = |L_2| = 1$ , and  $|L_3| = 2$ , and one of our main results is  $|L_{22}| = 2263$ . The outline of the first algorithm is as follows:

$i$	1	2	3	4	5	6	7	8	9
$L_i$	1	1	2	5	12	35	108	368	1283
$i$ -ominos	1	1	2	5	12	35	108	369	1285
$i$	10	11	12	13	14				
$L_i$	4600	16388	57439	193383	604269				
$i$ -ominos	4655	17073	63600	238591	901971				
$i$	15	16	17	18					
$L_i$	1632811	3469043	5182945	4917908					
$i$ -ominos	3426576	13079255	50107909	192622052					
$i$	19	20	21	22					
$L_i$	2776413	882062	133037	2263					

Table 1: The number of common partial developments of two boxes  $1 \times 1 \times 5$  and  $1 \times 2 \times 3$  of surface area  $i$  with  $1 \leq i \leq 22$ . (For  $1 \leq i \leq 18$ , we give the number of  $i$ -ominos, for comparison.)

**Input** : None;

**Output**: Polygons that consist of 22 squares and fold to boxes of size  $1 \times 1 \times 5$  and  $1 \times 2 \times 3$ ;

```

1 let  $L_1$  be a set of one unit square;
2 for  $i = 2, 3, 4, \dots, 22$  do
3    $L_i := \emptyset$ ;
4   for each common partial development  $P$  in
5      $L_{i-1}$  do
6     for every polygon  $P^+$  of size  $i$  obtained by
7       attaching a unit square to  $P$  do
8       check if  $P^+$  is a common partial
9         development, and add it into  $L_i$  if it is a
10        new one;
11    end
12  end
13 end
14 output  $L_{22}$ ;
```

We implemented the algorithm and obtain all common developments in  $L_{22}$ <sup>2</sup>. One can find all of them at <http://www.jaist.ac.jp/~uehara/etc/origami/net/all-22.html>. All the values of  $L_i$  with  $1 \leq i \leq 22$  are shown in Table 1. The first main theorem is as follows:

**Theorem 1** *The number of the common developments of boxes of size  $1 \times 1 \times 5$  and  $1 \times 2 \times 3$  into unions of unit squares is 2263.*

### 3 Boxes including doubly-covered rectangles

#### 3.1 Three boxes of surface area 22

Among the 2263 developments in Theorem 1, there is only one development that gives an affirmative answer

<sup>2</sup>The first program with a naive implementation was too slow. We tuned it with many technical tricks, and now it outputs  $L_{22}$  in around 10 hours.

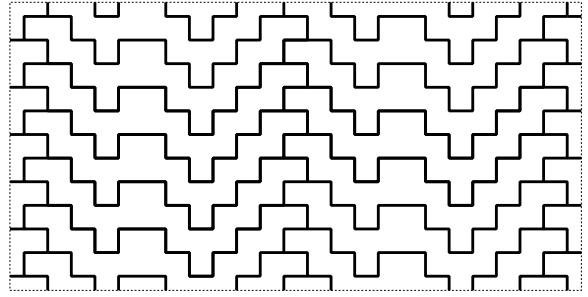

Figure 4: Tiling by the common development of three different boxes.

to the open problem in [5]:

**Theorem 2** *There is a common development of three boxes of size  $1 \times 1 \times 5$ ,  $1 \times 2 \times 3$ , and  $0 \times 1 \times 11$ . Moreover, the development is a polygon such that (1) it can fold to three boxes by orthogonal folding lines, and (2) it forms a tiling.*

**Proof.** The development is depicted in Figure 2. It is easy to see that all folding lines in Figure 2(a)-(c) are orthogonal. The tiling is given in Figure 4.  $\square$

In Theorem 2(1), one may complain that some folding lines are not on the edges of unit squares. Then, split each unit square into four unit squares. On the refined development for three boxes of surface area 88, we again have the claims in Theorem 2 for the boxes of size  $2 \times 2 \times 10$ ,  $2 \times 4 \times 6$ , and  $0 \times 2 \times 22$ , and all folding lines are on the edges of unit squares.

#### 3.2 A rectangular strip can be folded to an arbitrary number of doubly-covered rectangles

**Theorem 3** *A rectangular  $L \times 1$  paper ( $L > 1$ ) can be folded into at least*

$$2 + \lfloor L \rfloor$$

*different doubly-covered rectangles in at least*

$$1 + \lfloor \frac{L}{4} \rfloor + \lceil \frac{L}{4} \rceil + \lfloor L \rfloor$$

*different ways.*

**Proof.** Figure 5a shows how a long ribbon of width 1 can be wrapped by “twisting” it around a rectangular strip. Here we show that we can obtain  $\lfloor L \rfloor$  different doubly covered rectangles based on this way. First, we consider the points  $p_0, q_0, q_1, a, b, c$ , in Figure 5b). (Without loss of generality, we assume that  $q_0b \geq q_1a$ .) Let  $p_1$  be the center of  $bc$ , and  $h_i$  is the point such that  $p_ih_i$  is a perpendicular of  $ab$  for  $i = 0, 1$ . We first observe that  $p_0a$  and  $bc$  are in parallel, the angles  $ap_0b$  and  $p_0bc$  are right angles, and  $p_0$  is the center of  $q_0q_1$ .

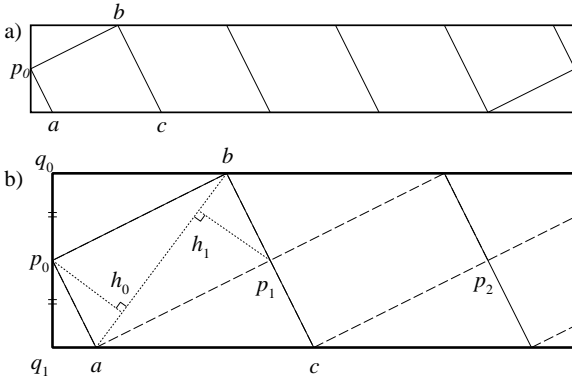

Figure 5: Another way of folding a ribbon to a doubly-covered rectangle

Thus, careful analysis tells us that  $\triangle q_0 p_0 b$ ,  $\triangle h_0 p_0 b$ , and  $\triangle h_1 p_1 a$  are congruent. By symmetry,  $\triangle q_1 p_0 a$ ,  $\triangle h_0 p_0 a$ , and  $\triangle h_1 p_1 b$  are also congruent. Hence the points  $a p_0 b p_1$  form a rectangle. Therefore, the folding lines in Figure 5a) can be obtained by filling the rectangles like Figure 5b). Let  $k$  and  $w$  be the number of the rectangles and the length of the diagonal of the rectangle, respectively. Then, to obtain a feasible folding lines, we need  $k \geq 1$ ,  $kw = L$ , and  $w = ab \geq 1$ . Therefore, for each  $k = 1, 2, \dots, \lfloor L \rfloor$ , we can obtain a doubly covered rectangle of size  $p_0 b$  and  $k p_0 a$ .

In addition, we have the two ways of folding the ribbon in half along the long axis (leading to a  $L \times \frac{1}{2}$  rectangle) or along the short axis (leading to a  $(L/2) \times 1$  rectangle).

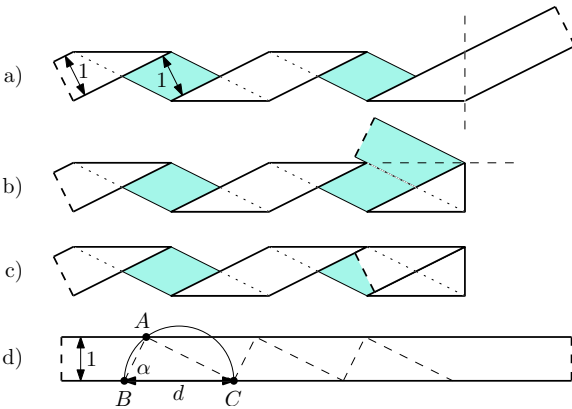

Figure 6: Folding a ribbon to a doubly-covered rectangle. For better visibility, one side of the ribbon is shaded.

We next turn to another idea of folding. Figure 6a shows how a long ribbon of width 1 can be wrapped by “winding” it around a rectangular strip in such a way that the space between successive windings is equal to the width of the ribbon. By bending it backward at the end, as in Figure 6b–c, one obtains a doubly covered

strip. Figure 6d shows the geometric construction: start with a right triangle  $ABC$  with the long side  $d = BC = \cot \alpha + \tan \alpha$  on a long edge of the ribbon and the right angle  $A$  on the opposite edge. When the length  $L$  of the ribbon is an even multiple of  $d$  ( $L = 2n \cdot d$ ), the folding will close into a doubly covered rectangle.

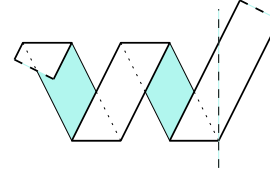

Figure 7: A different way of folding a ribbon to a doubly-covered rectangle

The minimum possible value of  $d$  is 2.  $d$  changes continuously with  $\alpha$ , and any value of  $d$  larger than 2 can be obtained. So  $n$ , the number of repetitions, can take all values between 1 and  $n_{\max} := \lfloor L/4 \rfloor$ . For each  $n$  in this range, one can form a right triangle  $ABC$  with hypotenuse  $d = L/(2n)$  and legs  $\frac{1}{2}(\sqrt{d^2 + 2d} \pm \sqrt{d^2 - 2d})$ . One can use the longer leg as the wrapping direction, as in Figure 6, or the shorter leg, as in Figure 7. This leads to doubly covered rectangles of dimensions  $(n \cdot \frac{1}{2}(\sqrt{d^2 + 2d} + \sqrt{d^2 - 2d})) \times \frac{1}{2}(\sqrt{d^2 + 2d} - \sqrt{d^2 - 2d})$  and  $\frac{1}{2}(\sqrt{d^2 + 2d} + \sqrt{d^2 - 2d}) \times (n \cdot \frac{1}{2}(\sqrt{d^2 + 2d} - \sqrt{d^2 - 2d}))$ .

For  $d = 2$ , the two possibilities coincide. So the total number of possibilities is  $\lfloor L/4 \rfloor + \lceil L/4 \rceil - 1$ . This equals  $2\lfloor L/4 \rfloor$  except when  $L$  is a multiple of 4. In this case, we have to subtract 1 to compensate the overcounting for the case  $d = 2$ .

But we can see that each doubly covered rectangle by winding can be also obtained by twisting. Hence we obtain  $2 + \lfloor L \rfloor$  different doubly covered rectangles in total.  $\square$

#### 4 Non-orthogonal polygons that fold to two incongruent boxes

Figure 8 shows a common unfolding of a  $4 \times 4 \times 8$  box and a  $\sqrt{10} \times 2\sqrt{10} \times 2\sqrt{10}$  box. It was obtained by solving an integer programming problem. The integer programming model formulates the problem of selecting a subset of 160 unit squares of the axis-aligned square grid underlying Figure 8, subject to the following constraints.

1. They should form a connected set in the plane.
2. When folded on the  $4 \times 4 \times 8$  box, every square of the surface is covered exactly once. (There are no overlaps.)
3. When folded on the  $\sqrt{10} \times 2\sqrt{10} \times 2\sqrt{10}$  box, every part of the surface is covered exactly once. Note

that the surface of the  $\sqrt{10} \times 2\sqrt{10} \times 2\sqrt{10}$  box can be partitioned into 160 unit squares, which are however not aligned with the edges of the box. These squares result from folding the standard grid onto the box surface as shown in Figure 8. Some of these squares bend across an edge of the box.

The algorithm of Section 2 can be viewed as a systematic incremental way of finding all solutions to this problem.

The dimensions of the boxes were chosen as follows: A  $1 \times 1 \times 2$  box has surface area 10, and a  $1 \times 2 \times 2$  box has surface area 16. By scaling the first box with the factor 4 and the second box with the factor  $\sqrt{10}$ , we get two boxes with equal surface areas. A square lattice of side length  $\sqrt{10}$  can be embedded on the standard integer grid by choosing the vector  $\begin{pmatrix} 1 \\ 3 \end{pmatrix}$  as a generating “unit vector”.

The alignment of the two box unfoldings, with the symmetric layout of two “central” faces sharing two vertices, was fixed and was chosen by hand.

Figure 9 has been made from Figure 8 in an attempt to conceal the obvious folding directions. Further puzzles along these lines (for printing and cutting out) are given on a web page<sup>3</sup>.

## 5 Concluding remarks

It is an open question if a polygon exists that can fold to three or more orthogonal boxes such that all of them have positive volume. We are exploring the possibility to find such examples by our integer programming model of Section 4. If we take the approach in Section 2, the smallest  $S$  with  $|P(S)| \geq 3$  is given by  $P(23) = \{(1, 1, 11), (1, 2, 7), (1, 3, 5)\}$ . Thus we need to construct polygons of surface area 46, which is much bigger than 22.

In Section 3.2, we use three different ideas for folding a rectangular ribbon  $R$  to a doubly-covered rectangle. It would be interesting to classify *all* ways of folding ribbons into doubly-covered rectangles. In fact, we can generalize the ideas of “twisting” and “winding”; see Figures 10 and 11. These folding ways correspond to a kind of the billiard ball problem on a rectangular table. Hence, to specify all the folding ways in the figures, we have to find all pairs of relatively prime integers  $p$  and  $q$  with  $pq = \lfloor cL \rfloor$  for  $c = 1, 1/4$ . The number of such pairs seems to be related to the maximal value of prime divisors of numbers in reduced residue system for  $\lfloor cL \rfloor$ .

<sup>3</sup><http://www.inf.fu-berlin.de/~rote/Software/folding-puzzles/>

<sup>4</sup><http://oeis.org/A051265>

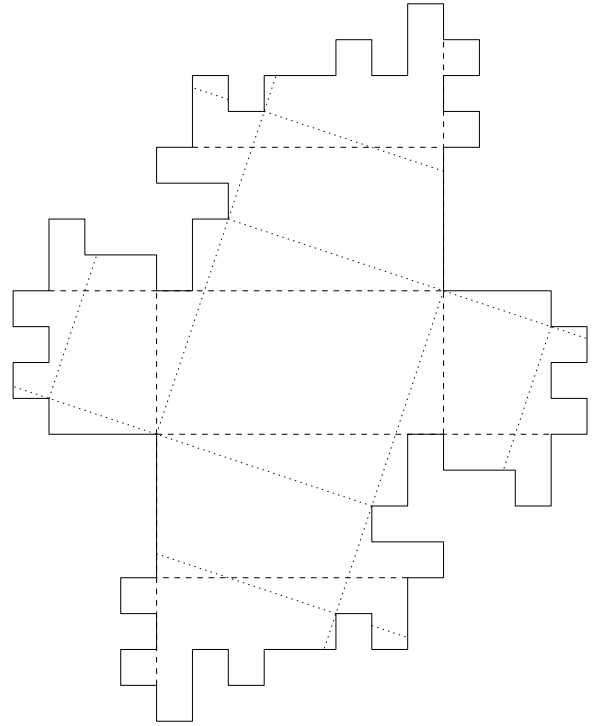

Figure 8: A common development of two different boxes. The set of folding lines for one box intersect the other set by neither 90 nor 45 degrees, but at  $\arctan 3 \approx 72^\circ$ .

## Acknowledgments

This work was initiated at the 26th Bellairs Winter Workshop on Computational Geometry held February 11–18, 2011 in Holetown, Barbados, co-organized by Erik Demaine and Godfried Toussaint. We thank the other participants of that workshop—Oswin Aichholzer, Greg Aloupis, Prosenjit Bose, Mirela Damian, Vida Dujmović, Robin Flatland, Ferran Hurtado, Anna Lubiw, André Schulz, Diane Souvaine, and Andrew Winslow—for helpful comments and for providing a stimulating environment.

## References

- [1] J. Akiyama. Tile-Makers and Semi-Tile-Makers. *The Mathematical Association of America*, Monthly 114:602–609, August–September 2007.
- [2] T. Biedl, T. Chan, E. Demaine, M. Demaine, A. Lubiw, J. I. Munro, and J. Shallit. Notes from the University of Waterloo Algorithmic Problem Session. September 8 1999.
- [3] E. D. Demaine and J. O’Rourke. *Geometric Folding Algorithms: Linkages, Origami, Polyhedra*. Cambridge University Press, 2007.

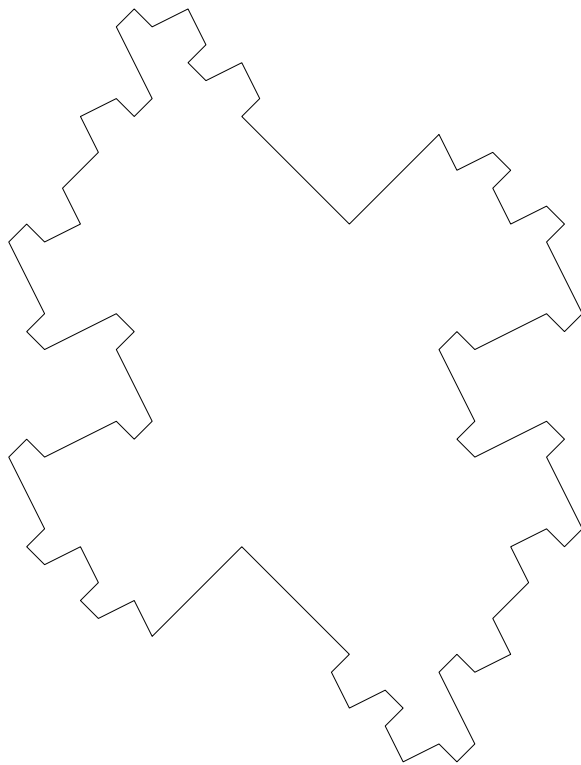

Figure 9: A common development of two different boxes. This has been obtained from Figure 8 by modifying the boundary.

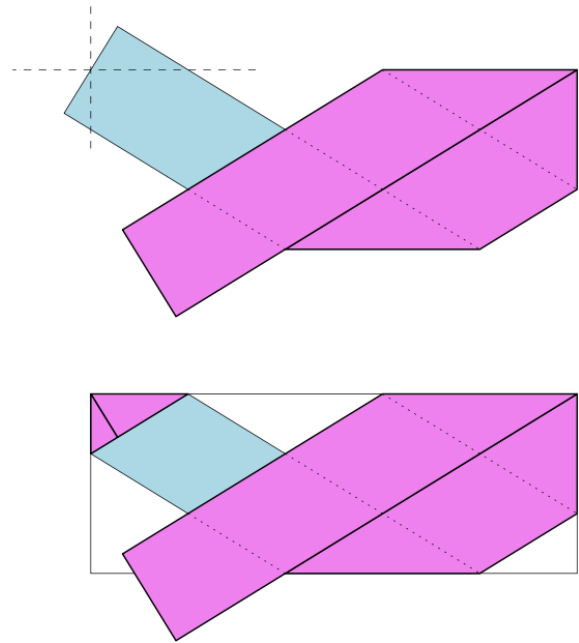

Figure 10: A generalization of twist folding to a doubly covered rectangle.

- [4] A. Lubiw and J. O'Rourke. When Can a Polygon Fold to a Polytope? Technical Report Technical Report 048, Department of Computer Science, Smith College, 1996.
- [5] J. Mitani and R. Uehara. Polygons Folding to Plural Incongruent Orthogonal Boxes. In *Canadian Conference on Computational Geometry (CCCG 2008)*, pages 39–42, 2008.

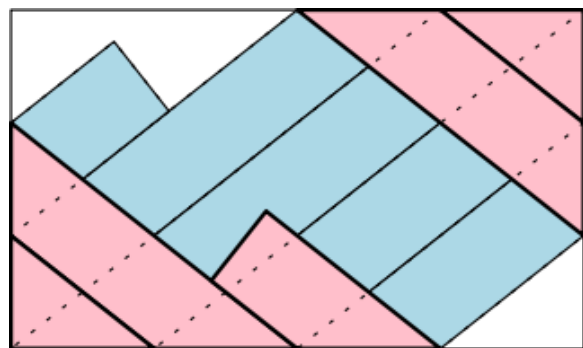

Figure 11: A generalization of wind folding to a doubly covered rectangle.