

Title	Development of a 2D communication sensor network using a single carrier frequency for both power and data transmission
Author(s)	Zhang, Bing; Oota, Toshifumi; Lim, Azman Osman; Kado, Youiti
Citation	IEICE TRANSACTIONS on Communications, E93-B(11): 2945-2955
Issue Date	2010-11-01
Type	Journal Article
Text version	publisher
URL	<a href="http://hdl.handle.net/10119/10322">http://hdl.handle.net/10119/10322</a>
Rights	Copyright (C) 2011 The Institute of Electronics, Information and Communication Engineers (IEICE). Bing Zhang, Toshifumi Oota, Azman Osman Lim, and Youiti Kado, IEICE TRANSACTIONS on Communications, E93-B(11), 2011, 2945-2955. <a href="http://dx.doi.org/10.1587/transcom.E93.B.2945">http://dx.doi.org/10.1587/transcom.E93.B.2945</a>
Description	

# Development of a 2D Communication Sensor Network Using a Single-Carrier Frequency for both Power and Data Transmission

Bing ZHANG<sup>†a)</sup>, Member, Toshifumi OOTA<sup>†</sup>, Nonmember, Azman-Osman LIM<sup>††</sup>, Member, and Youiti KADO<sup>†</sup>, Nonmember

**SUMMARY** Two-dimensional (2D) communication is a novel physical communication form that utilizes the surface as a communication medium to provide both data and power transmission service to the sensor devices placed on the surface's top. In previous works, we developed 2D communication systems that utilize separated channels for data and power transmission. Though this assignment of different channels can achieve strong network performance, the sensor devices must be equipped with two or more interfaces to simultaneously receive the power and data signals, which significantly complicates and enlarges those devices. Moreover, when a channel is used for the power supply, it not only continually monopolizes the wireless frequency resource, it is also likely to cause interference with the other signal source in the case of the input power continually being sent out above a certain level. In this paper, we develop a novel 2D communication sensor system by using a single-carrier frequency for both power and data transmission, equipped with the wireless module for the two together in a compact body. To enable a sensor node that concurrently receives energy and data communication, we propose an enhancement scheme based on the IEEE802.15.4 MAC protocol standard. Through both computer simulation and actual measurement of the output power, we evaluate the performance of power supply and data transmission over the developed 2D communication sensor system.

**key words:** 2D communication system, sensor network, power supply, concurrent scheme

## 1. Introduction

Ubiquitous communication is an area that has been rapidly growing area in recent years and a great deal of innovative research and development in this area has brought this concept to real applications that are beneficial in our daily lives. Networks of small wireless-sensing devices present significant new opportunities for ubiquitous communication. The challenges in deployment of ubiquitous sensor networks are physical connection and power supply for a large amount of sensors, which not only prohibits manual setup of a network and necessitates autonomous operation, but also eliminates the option of battery replacement, placing critical importance on the power supply. Two-dimensional (2D) communication technology has huge potential as a ground-breaking

technology for realizing ubiquitous sensor networks, because innovative 2D communication systems can simultaneously provide both data communication and power transmission to the sensor devices placed atop it. Such systems utilize a 2D sheet as a communication medium to provide room-sized communications and other services to the sensor devices on top of it. This new form of 2D communication medium is not only able to establish a communication connection between two sensor devices; it can also provide high-speed transmission, power supply, high security, highly accurate estimation of the sensor's location, efficient spatial reuse, and other services.

The concept of "Networked Surface" was first proposed by Scott et al. in October 1998 at the Laboratory for Communications Engineering at Cambridge University [1], [2]. The core idea in relation to a surface as a medium for both power and networking was inspired by Pushpin [3] and Pin&Play [4] systems. Lifton and Paradiso [3] use pushpins and layered conductive boards, where direct contact to the conductive layers in the board is used to obtain power, whereas networking is established via infrared. To envisage high-speed networking capabilities, Laerhoven et al. [4] proposed that the conductive layer can be used as a bus network for pins. Instead of using pin-shaped connectors, Sekitani et al. [5] successfully manufactured a large-area power transmission sheet by using printing technologies. The major disadvantage of this system is the issue of capacitive coupling, which requests that the device is put in an exact position on top of the transmitter.

A 2D communication system (2DCS) utilizes the surface as the communication medium to perform both data and power transmission wherever the device is placed atop the 2D sheet by confining the microwave in a thin sheet [6]–[8]. When a connector is placed atop the sheet an electromagnetic proximity connection is obtained, and a connector can thereby inject/extract the electromagnetic signal into/from the sheet. In previous work, we developed 2D communication systems by using the separated channels for data and power transmission [7], [8]. However, when the different channels are assigned to the power and data transmissions, respectively, two or more interface circuits are needed to simultaneously receive the power and data signals, which largely decreases flexibility in hardware design and implementation on sensor devices. Since each sensor device should be small-sized, lightweight and cheap, equipping it with two or more interfaces greatly aggravates the

Manuscript received March 2, 2010.

Manuscript revised June 22, 2010.

<sup>†</sup>The authors are with the Medical-ICT Group, New Generation Wireless Communications Research Center, National Institute of Information Communications Technology (NICT), Kyoto-fu, 619-0288 Japan.

<sup>††</sup>The author is with the Department of Computer Systems and Networks, School of Information Science, Japan Advanced Institute of Science and Technology (JAIST), Nomi-shi, 923-1292 Japan.

a) E-mail: zhang@nict.go.jp

DOI: 10.1587/transcom.E93.B.2945

problem. Moreover, when a channel is assigned to the power supply, it continually monopolizes the wireless frequency resource. Particularly, when input power is continually sent out above a certain level it is likely to cause interference with the other signal source. This seems to create the need for a stop interval for the input power, which results in wasting of the wireless frequency resource.

In this paper, we propose and build a novel 2D communication sensor system by using a single carrier frequency for both power and data transmission. To enable a sensor node that concurrently receives power and data signals, we propose an enhancement scheme based on the IEEE802.15.4 MAC protocol standard, which enables the device to charge its own power to correspond to the power charging status. Through both computer simulation and actual measurement of the output power, we evaluate the performance of power and data transmission over the developed 2D communication sensor system.

The rest of this paper is organized as follows. Section 2 briefly reviews related works and gives an overview of the proposed 2D communication system. Section 3 describes the power charging state transition for the power supply management. Then in Sect. 4 we propose a concurrent power supply and data transmission (PSDT) protocol in conjunction with the IEEE802.15.4 MAC protocol. The simulation settings, scenarios, and results are described in Sect. 5, and the experiment setup and results are presented in Sect. 6. The last section concludes the paper.

## 2. Surface as a Communication Medium

### 2.1 Related Works

A dearth of research has been published in relation to surfaces as a medium for power and networking. The core idea was first inspired by Scott et al. in October 1998 at the Laboratory for Communications Engineering at Cambridge University. Scott et al. [1], [2] named their idea a “Networked Surface.” The Networked Surface is primarily aimed at connection of higher-end computational devices (e.g., handhelds and laptops) that are placed atop a surface such as desk or table.

However, Lifton and Paradiso [3] used a surface with pushpins and layered conductive sheets, where direct contact to the conductive layers in the board is used to obtain power, whereas networking is established via infrared. To envisage high-speed networking capabilities, Laerhoven et al. [4] proposed that the conductive layer can be used as a bus network for pins.

Instead of using pin-shaped connectors, Sekitani et al. [5] successfully manufactured a large-area power transmission sheet by using printing technologies. The position of electronic objects on the sheet can be contactlessly sensed by electromagnetic coupling using an organic transistor active matrix. Power is selectively fed to the objects by an electromagnetic field using a plastic MEMS-switching matrix. The major disadvantage of this system is the issue of

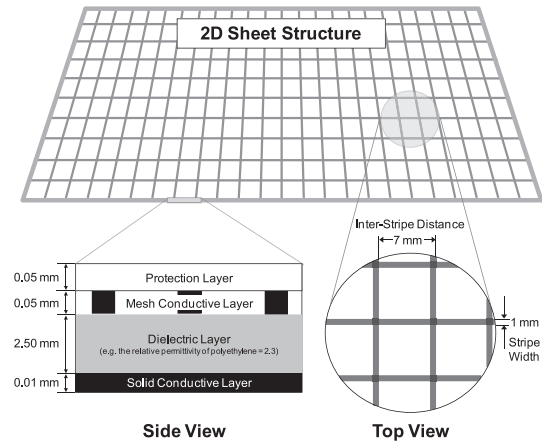

Fig. 1 Basic structure of the 2D sheet.

capacitive coupling. This is because it is difficult for people to place the receiver at the right position atop the transmitter.

To tackle the mismatching problem on the connector, Yamahira et al. [6] introduced a simple 2D communication system whereby a proximity connector touches the surface freely with restraint for power supply or data transmission. The connectors for power supply and data transmission proposed in [6] work separately. Therefore we propose a MAC protocol that can simultaneously provide both data transmission and power supply functions in a 2D communication system [7], [8]. This original idea is our focus for studying the concurrent power supply and data transmission protocol for 2D communication systems in this paper.

### 2.2 2D Communication System Overview

A 2D communication system (2DCS) consists of two components: a sheet and a connector. Figure 1 illustrates the basic structure of the 2D sheet, which is composed of four layers: solid conductive (S-) layer, dielectric (D-) layer, mesh conductive (M-) layer, and protection (P-) layer. The conductive fabric is usually copper or aluminium, whereas the dielectric material is polystyrene. The purpose of the P-layer is to protect humans from directly coming in contact with the M-layer. With this layered composition, an electromagnetic (EM) wave can be confined within the 2D sheet depending on the relative permittivity of the D-layer and the mesh structure of the M-layer. When the frequency of EM is 2.4 GHz and the relative permittivity of D-layer is 2.3, the inter-stripe distance and the stripe width of M-layer can be set to 7 mm and 1 mm, respectively. However, the EM wave can still be seeped out from the surface of the 2D sheet. We called this phenomenon an “evanescent wave.” The evanescent wave is formed when the EM wave inside the 2D sheet is reflected off the surface. The term “evanescent” means “tending to vanish.” This is because the intensity of evanescent waves decays exponentially according to the distance from the surface of the 2D sheet to the air. Meanwhile, the connector is an antenna by which an electromagnetic wave is extracted from or inserted into the 2D sheet. Since the

connector is one type of antenna, the design of the connector is not described in this paper. An example of the connector was designed and proposed by Yamahira et al. [6]. The proposed connector consists of metal, dielectric material with the relative permittivity of 10.5, and a sub-miniature type-A (SMA) connector to a 50 Ω cable. The radius of the connector was also determined so that the reflection of the electromagnetic wave from the connector to a cable is minimized at the frequency of 2.4 GHz.

### 3. Charging State Transition for Power Supply Management

The 2DCS can potentially be used for sensing across a range of home applications; for instance measuring the living room temperature and uploading the measured data to the Internet. However, many battery-operated sensors have energy constraints. Most of the existing MAC protocols for such networks are also designed to deal efficiently with energy limited resources in order to maximize the network lifetime. To enable the MAC protocol to control the power supply, in this section we first give the architecture of coordinator and sensor devices, and then the charging state transition diagram for the sensor device. For the power supply management, we finally propose that the coordinator device hold a power supply management table to control the power supply states in the sensor devices.

#### 3.1 Architecture of 2D Communication Coordinator and Sensor Devices

Figure 2 shows the fundamental architecture of the coordinator and sensor devices. Both have the same modules for information processing, IEEE 802.15.4, radio frequency (RF) circuit, and transmitter/receiver (TX/RX) antenna. The coordinator device provides the power supply to the sensor devices using the power carrier signals. When the communication signal is transmitted from the coordinator, it is amplified to almost the same level as the power supply signal by the amplifier power circuit module. Upon receiving the pure carrier signal, the power is charged by the energy-charging circuit in the sensor device. Meanwhile, upon receiving the amplified communication signals from the coordinator, it is

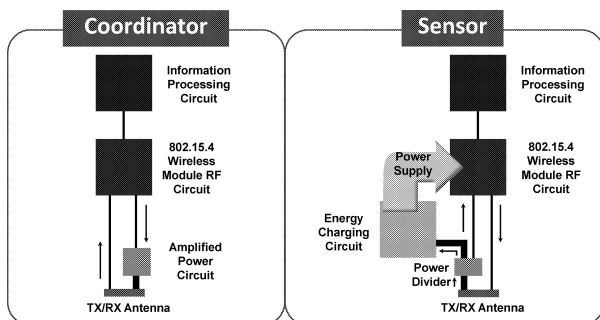

Fig. 2 Basic structure for coordinator and sensor devices.

largely reduced by the divider to prevent the reception circuit breaking due to an overly strong signal input to the sensor device. In this paper, we ignore the design and performance of the antenna.

#### 3.2 Charging State Machine Running on the Device

The energy storage circuit part of the device has the ability to store energy automatically in its storage (hereinafter referred to as a “battery”). In order to monitor the battery level of the device, we introduce five levels: maximum, recharge, enough, alert, and halt. Figure 3 illustrates how the battery levels of devices vary over time. The battery state machine is introduced to monitor the states of the battery in corresponding to the battery levels. As shown in this figure, there are five states: idle, normal, require, alert, and halt. Conditions for state transition depend on the battery status and alert interval. Based on these states, each device can easily monitor the battery level. Figure 4 shows the battery state machine running on the device. In order to perform this state machine, each device must encompass two entries: battery level (B) and timer for Alert Interval (T). Based on these two parameters, the ANTF and ENTF frames are generated by

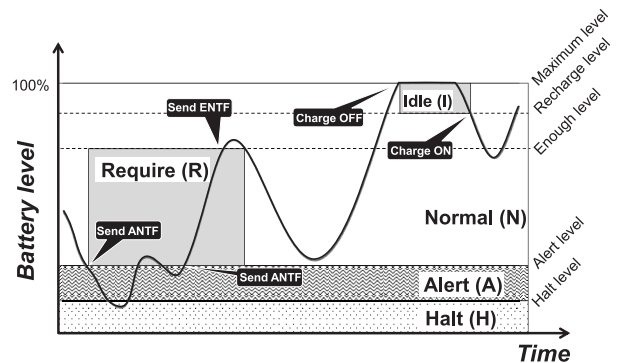

Fig. 3 Diagram of battery level variation with time.

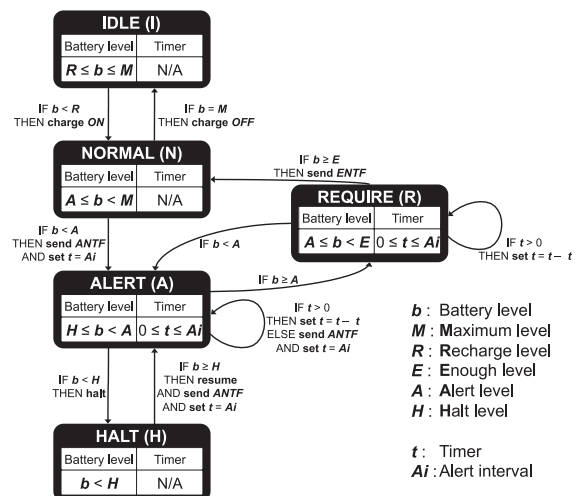

Fig. 4 Battery state transition running on device.

each device and the charging function of each device can be switched to ON or OFF.

As indicated by Fig. 3, when the battery level goes below the alert level from the normal state, the device will send an alert notification (ANTF) frame to acknowledge that the coordinator for its own battery status is in an alert state. Being in the alert state is a critical issue for the device, thus we introduce a timer, which is set to an integer value of Alert Interval. This timer counts down until it reaches zero seconds. According to the battery state transition shown in Fig. 4, at the zero of timer, when the battery level is still below the alert level, the device will send another ANTF and resets the timer. Otherwise, when the battery level goes above the alert level, the devices will do nothing. Furthermore, when the battery level goes below the halt level, the device will immediately suspend its communication function. By contrast, when the battery level goes above the enough level, the device will send an enough notification (ENTF) frame to acknowledge that the coordinator for its own battery status is normal. When the battery level goes above the maximum level, the device will stop charging its battery. When the battery level goes below the recharge level, the device will again start charging its battery.

### 3.3 Power Supply Management Table

The coordinator is assumed to have a power supply management (PSM) table. Upon receiving either the ENTF frame or ANTF frame, the coordinator updates the PSM table corresponding to the ID and status of the sent device and the coordinator must reply with an acknowledgment (ACK) for every received ENTF frame or ANTF frame. Figure 5(a) shows an example of the PSM table. The fields of the PSM table are ID, status, and time stamp. The address field represents the device sender address of the received ENTF frame

ID	Status	Time Stamp
1	Alert	100
2	Enough	-
3	Enough	-
...	...	...

(a) PSM table

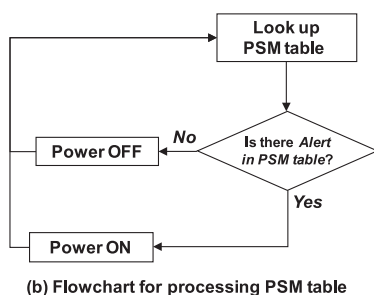

(b) Flowchart for processing PSM table

Fig. 5 Example of PSM table and flowchart for processing the PSM table.

or ANTF frame. The status field represents whether the device is in the alert or enough mode. The time stamp field represents that the time for an entry is stored and is used to monitor the expiration of the alert entry only. Upon receiving the ANTF frame, the expiration time for alert entry is set to three times the Alert\_Interval. The purpose of the expiration time is to prevent the coordinator continuously supplying the power to a device that was removed from the 2D sheet. After expiring, an alert entry automatically changes to an enough entry. An alert entry is also changed to an enough entry if the ENTF frame is received with the same sender address. The power supply is ON when there is at least one alert entry in the PSM table. Otherwise it is OFF. Figure 5(b) summarizes the ON/OFF switch of the power supply into a flowchart for processing the PSM table at the coordinator.

## 4. Concurrent Power Supply and Data Transmission Scheme

A conventional MAC protocol for sensor networks is designed for data transmission and energy management, but none of the existing protocols is applicable for 2D sensor networks, which can provide both data and power transmission. To enable a sensor device that concurrently receives energy and data communication, we propose an enhancement scheme based on the IEEE802.15.4 MAC protocol standard, which is simply modified for adding the power supply feature at the first preliminary stage of protocol implementation. In the following subsections, we discuss the consideration and modifications of the sensor device and coordinator to concurrently deal with data transmission and power supply functions over the 2D sensor system.

### 4.1 IEEE 802.15.4 MAC Protocol Overview

The IEEE 802.15.4 MAC standard defines an optional superframe structure; which is initiated by, and its format is decided by, the coordinator. As Fig. 6 shows, the superframe is bounded by network beacons and contains both an active and inactive period. The active period consists of 16 equally sized slots, and contains the frame beacon, contention access period (CAP) slots, and contention free

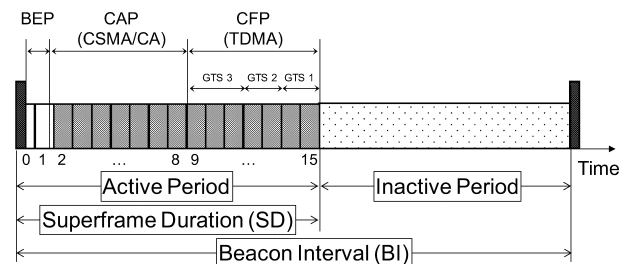

CAP: Contention Access Period      GTS: Guaranteed Time Slot  
 CFP: Contention Free Period      BEP: Beacon Extension Period

Fig. 6 Superframe structure of IEEE 802.15.4 MAC protocol specification.

period (CFP) slots. The first time slot of each superframe is used to transmit the beacon. The beacon’s main purpose is to synchronize the attached devices, identify the coordinator, and describe the superframe structure. The remaining slots are used by competing devices for communications during the CAP. The devices use a slotted CSMA/CA-based protocol to gain access to compete for the time slots. All communications between devices must conclude by the end of the current CAP. To satisfy the latency and bandwidth requirements of the supported applications, the coordinator may dedicate a group of contiguous time slots of the active superframe to these applications. These are labelled as guaranteed time slots (GTSs), and their number cannot exceed seven. As shown in Fig. 6, the CFP always appears at the end of the active superframe and starts a slot boundary immediately following the CAP. The inactive period defines a time period during which all network devices, including the coordinator, can enter a sleep mode in order to reduce energy consumption. In this mode, the network devices switch off their power and set a timer to wake up immediately before the announcement of the next beacon frame.

#### 4.2 Design Considerations

To supply sufficient power to the devices, we propose that the inactive period is used by the coordinator to supply power to the devices if applicable. We called this inactive period as a “power supply phase,” which indicates that the continuous NULL packet transmissions are broadcasted by the coordinator to the devices. The main reason for this is that the coordinator can supply power to its devices without worrying about the window contention problem. Since the coordinator is also one of the network devices, it can still supply power to other devices during its data transmission. In other words, the coordinator takes the opportunity to supply power to other devices by sending a DATA packet during the CAP. Furthermore, the power divider of the device as shown in Fig. 2 enables the received power to be charged when the device is either in the awake or sleep mode. In general, the durations of superframe duration (SD) and beacon interval (BI) are triggered by using the parameters of the superframe order (SO) and beacon order (BO), respectively where  $BI = aBaseSuperframeDuration \times 2^{BO}$  and  $SD = aBaseSuperframeDuration \times 2^{SO}$ . The term *aBaseSuperframeDuration* here is the number of symbols forming the superframe defined in the IEEE802.15.4 standard. Therefore the coordinator uses the parameters of SO and BO to adaptively adjust the medium access depending on traffic demands, resource constraints, and other such factors. Indirectly, the coordinator can also efficiently monitor the power supply without disturbing the data transmission. Figure 7 shows the proposed superframe structure of the MAC protocol for both data communication and power supply with SO = 3 and BO = 4, in which the ratio of CAP and the inactive period is 1:1. These SO and BO values cannot guarantee the best performance of the proposed concurrent power supply and data transmission scheme, but this gives a clear un-

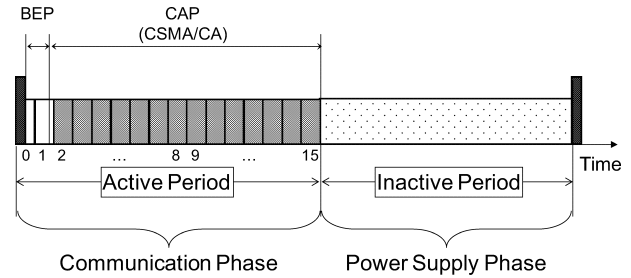

Fig. 7 Proposed superframe structure of MAC protocol for both data communication and power supply.

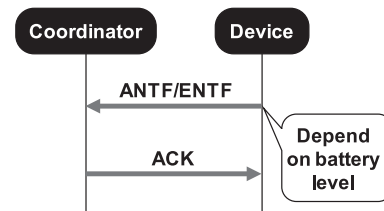

Fig. 8 ANTF/ENTF sequence from device to coordinator.

derstanding how the scheme is adaptable and applicable to accommodate various types of traffic such as periodic data, intermittent data, and repetitive low-latency data despite the energy constraints.

#### 4.3 Message Sequence

The IEEE 802.15.4 MAC protocol specifies beaconed and beaconless modes of operation. In this paper, we only focus on the beacon-mode operation, which allows devices within a network to synchronize their actions and coordinate communications with each other. Devices wake up only when a beacon is broadcast. A device registers with the coordinator and looks for any messages addressed to it. If no messages are pending, the device returns to sleep. To regulate access to the channel, the coordinator uses the superframe structure. As discussed above, the superframe is divided into 16 equally sized slots. Devices can compete for access to the channel during the CAP using the slotted CSMA/CA mechanism. For realizing the APS scheme, we propose the ENTF/ANTF message sequence as shown in Fig. 8. Each transmission of an ENTF frame or ANTF frame is followed by the ACK frame.

#### 4.4 Frame Format

IEEE 802.15.4 defines four basic frame types: beacon frame, data frame, ACK frame, and MAC command frame. The beacon frame is transmitted periodically by the coordinator. It serves multiple purposes, including identifying the network and its structure, waking up devices from sleep mode to listening mode, and synchronizing network operations. However, the data frame carries a payload of up to 104 octets. Each data frame carries a sequence number that uniquely identifies the frame. The ACK frame is used by

the receiver to acknowledge the receipt of a data frame. The MAC command frame is used by the MAC entities in different devices for negotiation and communication. We thus utilize the ANTF and ENTF frame as the MAC command frame, which format is defined in Fig. 9. Upon receiving either the ENTF frame or ANTF frame, the MAC-layer entity of the coordinator must process the received frame to determine the actions required to handle the frame properly.

4.5 Protocol Operation

In this section, we describe how the ANTF frame or ENTF frame operates with other frames based on the IEEE 802.15.4 MAC protocol. We assume that the coordinator has the PSM table at the initial operation. The ANTF frame or ENTF frame must follow the rule of the CSMA/CA-based protocol. When a device attempts to transmit the ANTF frame or ENTF frame, it must first sense the channel in the CAP interval. Upon transmitting the ANTF frame or ENTF frame, the device waits for the ACK frame from the coordinator. If it fails to receive the ACK frame, however, the device increases the number of backoffs before it makes another attempt to transmit the failed frame. Figure 10 shows the how the coordinator continuously send NULL packets corresponding to the received ANTF frame. If the ANTF frame is received, the coordinator updates its PSM table with the alert entry of the sent device. Then, the coordinator supplies power continuously in the power supply channel.

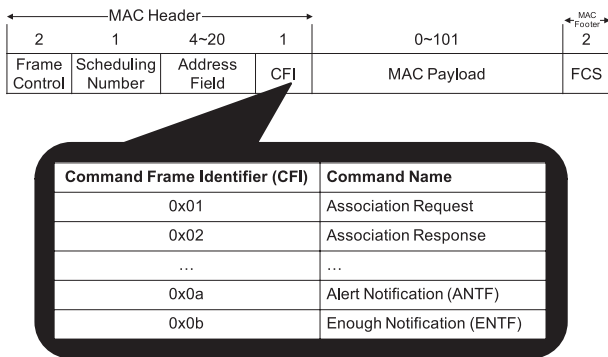

Fig. 9 Proposed frame format type for ANTF and ENTF.

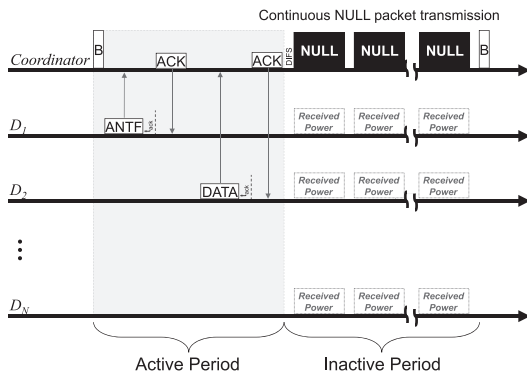

Fig. 10 Frame passing of ANTF and ENTF.

If the coordinator’s PSM table contains none of the alert entries, it stops supplying power.

5. Simulation Results

We examine the performance of the PSDT protocol by using the QualNet 4.5 simulator. In our simulation, all the sensors and one coordinator are placed on a 3 m × 3 m surface. In this research, we confirm the PSDT protocol behaviour with a pair of one coordinator and one sensor device. The coordinator is placed at the bottom-left corner of the simulation area whereas the sensor is placed at the top-right corner. We then focus on the influence of the power supply on the protocol performance. For that purpose, we prepare a simulation set with one coordinator whereby the number of sensors is 35. Figure 11 shows the grid topology with one coordinator and 35 sensors. The coordinator is placed at the bottom-left corner of the simulation area whereas all the sensors are placed in the form of a grid topology.

For the traffic model, a constant bit rate (CBR) traffic is assumed. The data payload size is set to 64 bytes, in which the data packet sends at an interval of 0.246 seconds. This interval value is equivalent to the beacon period when the beacon order (BO) is 4. In order to avoid packet collision, the generation time of the first data packet of each sensor is exponentially distributed. We run each simulation for 6 hours. Other parameters are summarized in Table 1.

5.1 Pathloss Model for 2D Communication Medium

The EM wave that propagates inside the 2D sheet is attenuated with the distance. In the wireless medium, the total signal power typically is assumed to decay with  $1/d^\alpha$ , where  $d$  is the distance from the transmitting side and  $\alpha$  is the pathloss coefficient of 3–4. However, in the 2D medium, the total signal power is assumed to decrease with distance, in which  $\alpha$  is equivalent to one based on the Friis transmission equation. Unlike a wireless medium, the total received power in a 2D medium can vary from the touched size of the

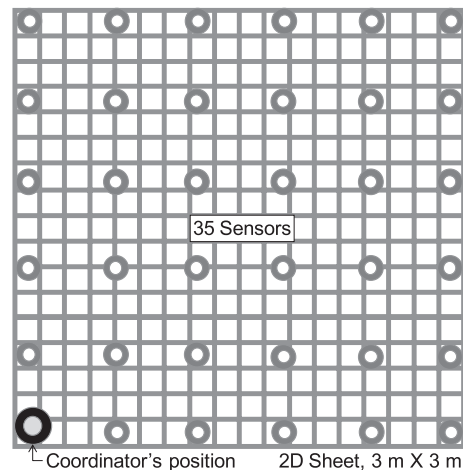

Fig. 11 Grid topology model.

**Table 1** Simulation parameters and settings.

Network simulator	QualNet 4.5
Physical characteristic	IEEE 802.15.4 (ZigBee)
MAC protocol	CSMA/CA (Beacon mode)
Data rate	250 kbps
Superframe order	3
Beacon order	4
Number of channels	1
2D sheet size	3 m × 3 m
Simulation time	6 hours
Traffic pattern	CBR
Data payload	64 bytes
Data interval	0.246 s
Core operating voltage	3.0 V
Transmit power consumption	60 mW
Receive power consumption	45 mW
Idle power consumption	45 mW
Sleep power consumption	0 mW
Sensing power consumption	15 mW
Propagation model	2D pathloss model
Connector diameter	6 cm
Battery model	Simple linear model
Battery initial capacity	50 mAh
Rectenna resistance	50 Ω
Nominal chargeable voltage	1.0 V
Sensing duration	0.1 s
Sensing interval	0.246 s
Alert interval	100 s
PSM expiration time	300 s

paper, we use Eq. (2) as the pathloss model for our simulation. We assume that the connector diameter is 6 cm.

### 5.2 Battery Model

The battery model is necessary for a battery-driven system, such as a sensor or mobile phone. This is because the battery model captures the characteristics of real-life rechargeable batteries, and can be used to predict system behaviour under various conditions of charge/discharge. The battery provides voltage and current for the components attached to the battery, such as radio interfaces, central processing units, memory blocks, and sensing modules. The battery is a repository of electricity charges, which loses its charge when an electrical current is taken from it. The unit of battery capacity is denoted as a milliampere hour (mAh). One mAh is the electric charge transferred by a steady current of 1 mAh per one hour. In this paper, a simple linear model is assumed for the battery model. This model is based on the coulomb counting technique, which respectively accumulates and dissipates linearly according to time when the battery charges and discharges. For simplicity, this model does not consider over-charging loss, charge/discharge efficiency, self-discharge loss, time durability, and cycle durability. If we assume the battery is lithium-ion, the charging capacity is given by

$$C_{char} = P_r \frac{T_{char}}{V_{nom}} \tag{3}$$

where  $V_{nom}$  is the nominal voltage for charging the battery and  $T_{char}$  is the charging time. In order to charge the battery, the received voltage of the connector should above the nominal voltage of the battery; otherwise the battery will not charge. We can obtain the received voltage by the following equation:

$$V_{received} = \sqrt{P_r R_{rectenna}} \tag{4}$$

where  $R_{rectenna}$  is the resistance of the rectenna. In our simulation, the nominal voltage is set to 1.0 V and the rectenna resistance is set to 50 Ω. The initial battery capacity of sensor is set to 50 mAh.

### 5.3 Simulation Results and Discussions

Figure 13 shows that the battery level varies with the simulation time for the one-sensor topology. When there is no power supply throughout the 2D sheet ( $P_S = 0$  W), the sensor depletes its energy in about 120 minutes. When there is a power supply, the battery level of the sensor reaches the alert, and at about 60 minutes in the simulation time, ANTf is sent to the coordinator. The coordinator receives the ANTf from the sensor and starts supplying energy to it. For  $P_S = 2.2$  W, the lifetime of the sensor extends to about 180 minutes. For  $P_S = 4.4$  W, the receiving energy and dissipating energy are almost balanced. For  $P_S = 8.8$  W, the battery is charged and when it reaches the enough level,

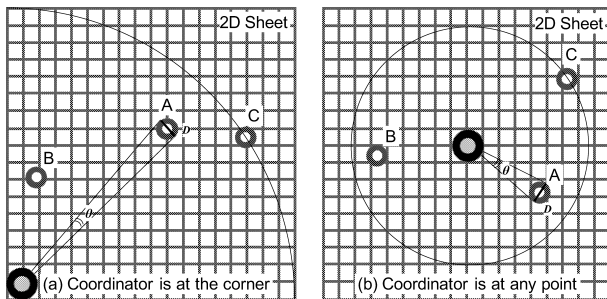

**Fig. 12** Pathloss model for 2D communication.

connector placed atop the 2D sheet. For simplicity, we can model the total received power proportional to the connector diameter ( $D$ ). The total received power in the 2D medium depends on the coordinator placement; either the coordinator is at any point on the 2D sheet or at the corner. Thus, the total received power when the coordinator is at any point can be expressed as

$$P_r = P_S \frac{D}{2\pi d} \tag{1}$$

And the total received power when the coordinator is at the corner can be expressed as

$$P_r = P_S \frac{2D}{\pi d} \tag{2}$$

where  $P_S$  is the power supply of the coordinator in watts. Figure 12 shows the 2D pathloss model when the coordinator is at any point or at the corner of the 2D sheet. In this



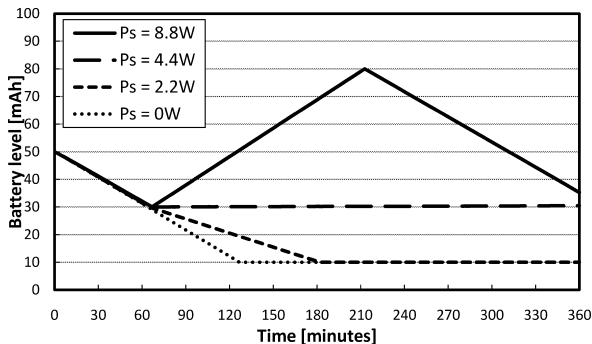

Fig. 13 Battery level varies with time for one-sensor topology network.

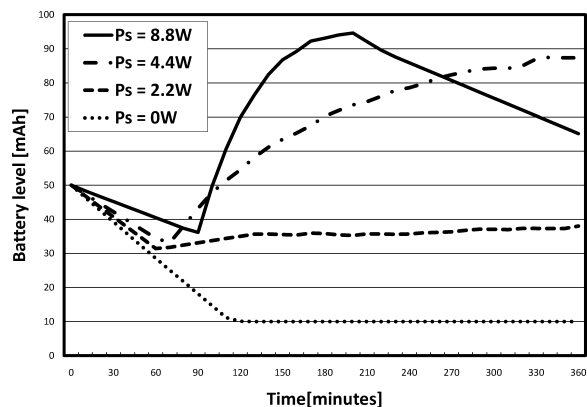

Fig. 14 Battery level varies with time for 35-sensor topology network.

ENTF is sent from the sensor to the coordinator at about 210 minutes. Upon receiving the ENTF message, the coordinator stops supplying energy, and the sensor then depletes its energy until it again reaches the alert level. Figure 14 shows that the battery level varies with simulation time for the 35-sensors topology. The battery level in Fig. 14 displays the average value of all of the sensor’s battery levels. When there is no power supply throughout the 2D sheet ( $P_S = 0\text{ W}$ ), all the sensors deplete all their energy for disseminating the data packets up to about 120 minutes. After 120 minutes, all the sensors are at a halt. We also can denote this as a network lifetime. In other words, the network lifetime when  $P_S = 0\text{ W}$  is about two hours. However, the sensor can continuously send out data packets when there is a power supply ( $P_S = 2.2\text{ W}$  or  $4.4\text{ W}$ ). For  $P_S = 2.2\text{ W}$ , some sensors located far away from the coordinator are running out of battery power whereas sensors located near the coordinator are strong enough to operate normally for sending their data packets until the end of the simulation. If we increase the power supply to double ( $P_S = 4.4\text{ W}$ ), all of the sensors function as usual without concern about the lack of battery capacity. We can summarize that the network lifetime is prolonged when there is a supply of power inside the 2D sheet.

Figure 15 shows that the goodput varies with the supplied power from the coordinator. Goodput is defined as the number of bits successfully received per unit time by the

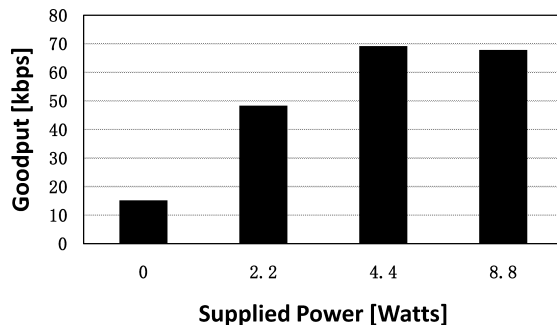

Fig. 15 Evaluation result of goodput for supplied power.

coordinator. As we can see from this figure, the goodput increases as the supplied power increases until the power supply is sufficient for all the sensors. When the supply power increases to  $P_S = 8.8\text{ W}$ , the goodput cannot be further improved. This is because the power supply of  $P_S = 4.4\text{ W}$  is already sufficient for all the sensors. The improvement seen from the cases of  $P_S = 0\text{ W}$  and  $P_S = 2.2\text{ W}$ , arises from the fact that some of sensor devices, especially located in a far distance from the coordinator, disrupt the data transmission to the coordinator due to the batteries running down. We can conclude that it is important to supply sufficient power using the 2D sheet for maintaining the good performance of sensors.

It is interesting research to investigate the energy reception efficiency when we take into account factors such as a real-life rechargeable battery model and 2D pathloss model with shadowing and reflection effects, etc.

### 6. Measurement Results

In this section, we present the 2D communication sensor system actually developed by using a single carrier frequency for both power and data transmissions. Figure 16 shows the experiment setup that mainly consists of the coordinator device, 2D communication sheet, and sensor device. The coordinator device is directly connected to electricity source, and provides the power by sending the power carrier signals and amplified communication signal from it. Figure 17 shows the front and back of the sensor device, which is equipped with four kinds of sensors: infrared, illuminance, acceleration and temperature. In the front of the sensor device, the display, LED lamp, and speaker are mounted, and the display shows the voltage value of the energy-charging circuit in the sensor device, and the states of brightness, person’s existence and movement. For simplicity, we use nine ceramic patch antennas, in which eight are for power supply and one is for data communication. The CC2430 chip is used as the IEEE802.15.4/ZigBee module.

Figure 18 shows the charging voltage variation curves with time; where the distances from the input connector are 5 cm, 15 cm, 25 cm, 45 cm, and 60 cm. The beacon interval is set to 1 second, in which 900 ms is set as the sleep time. The power carrier signal is sent during the sleep time.

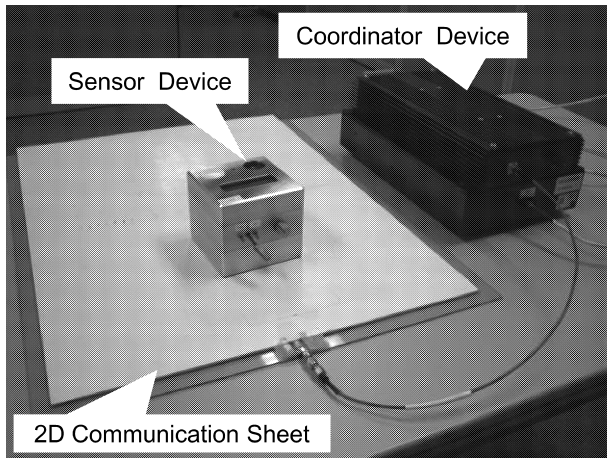
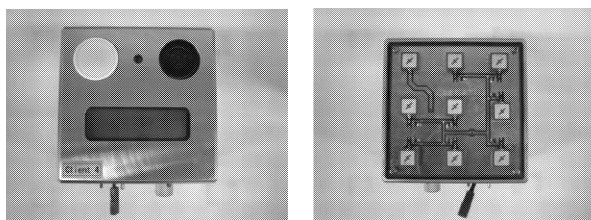

Fig. 16 Experiment setup.



(a) Display, speaker and lamp on the front (b) Antennas on the back

Fig. 17 Front and back of sensor device.

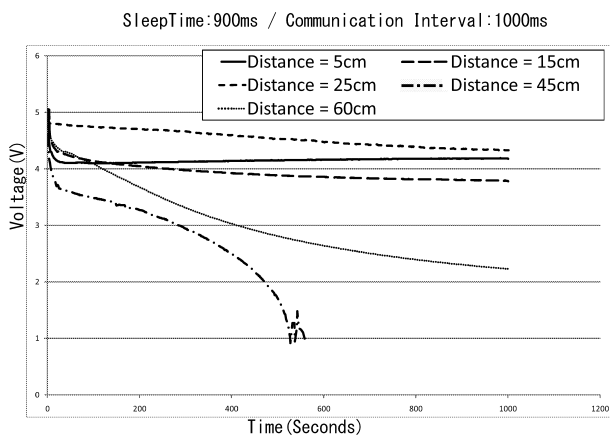

Fig. 18 Measurement result of charging voltage variation with time.

We can see that the farther the distance from the connector, the greater the voltage decays, except for the cases of distance = 25 cm, which is likely caused by the standing electromagnetic wave. Figure 19 also shows the charging voltage variation curves with time; in which 500 ms is set as the sleep time. Comparing Figs. 18 and 19, we can find that the smaller the sleep time, the more significantly the voltage decays, because the sensor device can be sufficiently charged over a long charge time.

Figure 20 shows the charging voltage variation curves with time; where the distance is very close to the input con-

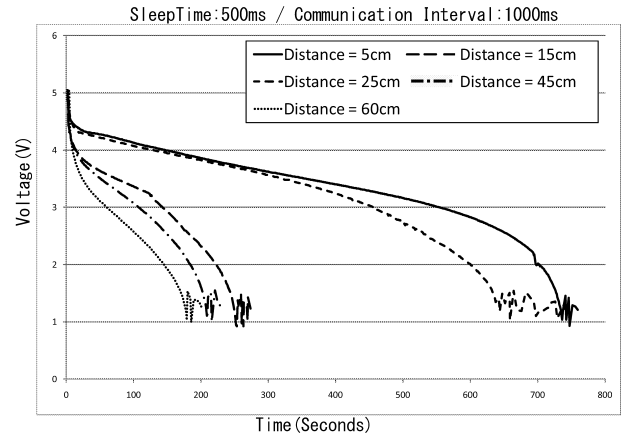

Fig. 19 Measurement result of charging voltage variation with time.

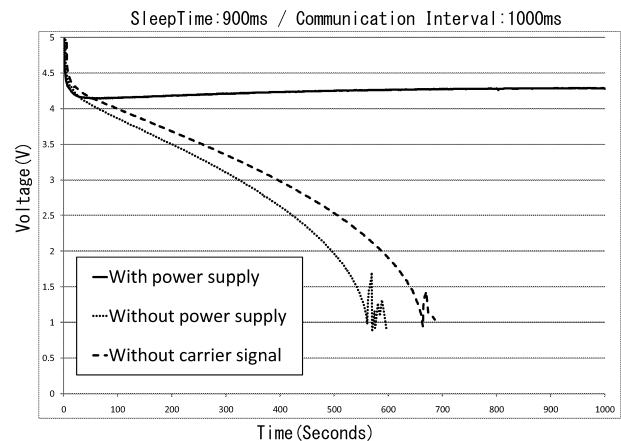

Fig. 20 Measurement result of charging voltage variation with time.

ductor, and the sleep time is set to 900 ms. We perform the measurements for three cases: the first case is that the power carrier signal is sent during the sleep time depicted by the solid line; in the second case the energy charging module is not included, depicted by the short dashed line; and in the third case the power is not sent during the sleep time, depicted by the dots. From the figure we can easily find that the best case is the first case depicted by the solid line, and the other two cases have similar results. Figure 21 shows that the charging voltage variation curves with time; where the distance is the same as with Fig. 20 and the sleep time is set to 500 ms. From Figs. 20 and 21, it is clear that the first case is the best case in Fig. 20; in which the energy-charging function is enough to support the sensor device equipped with the four kinds of sensors and data communication.

Comparing the simulation result of Fig. 13 with the experiment results from Fig. 18 to Fig. 21, we can observe that since the power supply is not sufficient to reach the enough level, the simulation results with  $P_s = 4.4$  W and 8.8 W cannot be confirmed in the actual experiment. Only the best case in Fig. 20 achieved a similar result with  $P_s = 2.2$  W in Fig. 13, in which the energy-charging function is enough to support the sensor device. Meanwhile, the lifetime of the

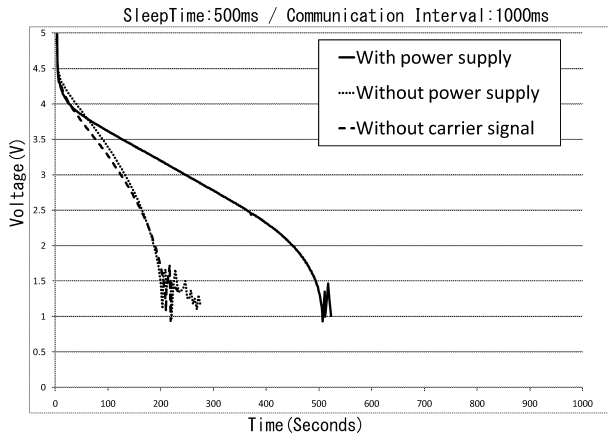

Fig. 21 Measurement result of charging voltage variation with time.

developed sensor device obtained from Fig. 18 to Fig. 21, is much shorter than one obtained from the simulation. This is because our developed sensor device is equipped with display, LED lamp, speaker and several kinds of sensors, all of which exhaust more a lot of energy than the sensor device in simulation.

## 7. Conclusion

We developed a novel 2D communication sensor network performing both power and data transmission with a single-carrier frequency, and proposed a concurrent power supply and data transmission scheme by enhancing the IEEE 802.15.4, which allows the sensor device to charge the power corresponding to the charging status.

In the first step, we used the QualNet 4.5 simulator to examine the performance of the PSDT protocol. Simulation results revealed that the lifetime and goodput of a network increase when the power supply is sufficient inside the 2D communication sensor system. In the second step, we actually measured the voltage value of the energy-charging module in the sensor device. The measurement results reveal that when the sensor device is positioned at a very close distance to the input connector, the power supply from the coordinator is sufficient to support the sensor device. However, when the sensor device is placed away from the input connector, the charging voltage gradually falls into a low-charging level. Also, the longer the distance from the input connector, and the shorter the sleep time, the greater the voltage decays in the sensor device.

As future work, instead of the patch antenna, we will develop a more efficient antenna to receive the power signal, with which the power supply is sufficient to support the sensor device wherever it is placed on the 2D sheet. We will also further evaluate the performance of the proposed concurrent protocol when we consider other factors like the real-life rechargeable battery model and different pathloss model with shadowing and reflection effects.

We hope that this paper stimulates research on fundamental understanding of 2D communication sensor net-

works and exploration of new application scenarios in order to achieve the ultimate goal of Internet access anytime, and not just at home but anywhere.

## References

- [1] J. Scott, F. Hoffmann, M. Addlesee, G. Mappt, and A. Hopper, "Networked surfaces: A new concept in mobile networking," Proc. IEEE Workshop on Mobile Computing Systems and Applications (WM-CSA), pp.11–18, 2000.
- [2] J. Scott, F. Hoffmann, M. Addlesee, G. Mappt, and A. Hopper, "Networked surfaces: A new concept in mobile networking," ACM Mobile Network and Applications, vol.7, no.5, pp.353–364, 2002.
- [3] J. Lifton and J. Paradiso, "Pushpin computing system overview: A platform for distributed, embedded, ubiquitous sensor networks," Proc. Pervasive Comp., Lecture Notes in Computer Science (LNCS), vol.2414, pp.139–151, 2002.
- [4] K.V. Laerhoven, N. Villar, A. Schmidt, and H.W. Gellersen, "Pin & play: The surface as network medium," IEEE Commun. Mag., vol.41, no.4, pp.90–95, 2003.
- [5] T. Sekitani, M. Takamiya, Y. Noguchi, S. Nakano, Y. Kato, K. Hizu, H. Kawaguchi, T. Sakurai, and T. Someya, "A large-area flexible wireless power transmission sheet using printed plastic MEMS switches and organic field-effect transistors," Proc. IEEE International Electron Devices Meeting (IEDM) Conf., pp.287–290, 2006.
- [6] N. Yamahira, Y. Makino, H. Itai, and H. Shinoda, "Proximity connection in two-dimensional signal transmission," Proc. SICE-ICASE Int. Joint Conf., pp.2735–2740, 2006.
- [7] A.O. Lim, T. Oota, and B. Zhang, "Adaptive power supply scheme and performance evaluation for 2-dimensional communication system," IEICE Technical Report, USN2008-43, 2008.
- [8] Y. Kado, A.O. Lim, K. Hattori, and B. Zhang, "Power supply and signal transmission for single frequency in two-dimensional communication system," IEICE Technical Report, USN2007-50, 2007.



**Bing Zhang** received the B.S. degree from Peking Aeronautics and Astronautics University, China in 1983. She received the M.S. and Ph.D. degrees from Hiroshima University, Japan in 1987 and 1990, respectively. Since 1991 she has been working at the Communication Research Laboratory (CRL) of Japan Ministry of Posts and Telecommunications (presently, National Institute of Information and Communications Technology), as a senior researcher. During 1995–1996, she was a post-doctoral research associate in the University of Tennessee, U.S.A. From 2000 to 2004, she was with the Adaptive Communications Research Laboratories of Advanced Telecommunications Research (ATR) Institute International as a senior researcher. Her research interests include ubiquitous communication, wireless mesh and sensor networks, two-dimensional (2D) communication. She is a member of IEEE and IEEJ.



**Toshifumi Oota** received the B.Eng. and M.Eng. degrees from Toyohashi University of Technology in 1994 and 1996, respectively. In 1996, he joined Kozo Keikaku Engineering Inc. Since 2008, he has been staying at the National Institute of Information and Communications Technology (NICT) as a Research Expert. His current research interests include 2D communication systems.



**Azman-Osman Lim** received the B.Eng. (Hons) and M.Inf. Technology degrees from Universiti Malaysia Sarawak (UNIMAS), Malaysia in 1998 and 2000, respectively. He received the Ph.D. degree in communications and computer engineering from Kyoto University in 2005. He was a visiting researcher at Fudan University in China for two months. During 2005–2009, he was an expert researcher at National Institute of Information and Communications Technology (NICT), Japan. Since 2009, he

has been working at Japan Advanced Institute of Science and Technology (JAIST) as an associate professor. His research interests include multihop wireless networks, wireless mesh networks, wireless sensor networks, heterogeneous wireless networks, 2D communication system, network coding, game theory, and capacity theory. He is a member of IEEE and IPSJ.



**Youiti Kado** received the B.Litt. degree from Kyoto University in 1992. He received the M.Eng. degree from Nara Advanced Institute of Science and Technology in 1995. He was an employee at Oki Electric Industry Co., Ltd., Japan for eleven years before he worked for Knowledge Creating Communication Research Center, NICT, Japan in 2005. His research interests include the wireless mesh and sensor networks, ATM networks, and knowledge processing.