

Title	A home environment simulator that supports thermal energy and power energy simulations in a co-generation energy system
Author(s)	BUI, Phuc
Citation	
Issue Date	2012-09
Type	Thesis or Dissertation
Text version	author
URL	<a href="http://hdl.handle.net/10119/10760">http://hdl.handle.net/10119/10760</a>
Rights	
Description	Supervisor:丹 康雄, 情報科学研究科, 修士

# Contents

<b>1 Introduction.....</b>	<b>3</b>
1.1 Home network system .....	3
1.2 Target of this research.....	4
1.3 Structure of this document.....	4
<b>2 Related Works .....</b>	<b>6</b>
2.1 Home network simulation .....	6
<b>3 Thermal energy simulation .....</b>	<b>9</b>
3.1 Energy System in the house.....	9
3.2 Hot water pipe system .....	10
3.3 Thermal Energy Simulation Model .....	11
3.3.1 Fuel cell system: .....	12
3.3.2 Behavior of FC system: .....	15
3.4 Relationships between simulation components.....	18
3.4.1 Relationship with the appliance simulation.....	18
3.4.2 Relationship with the environment simulation:.....	22
3.4.3 Relationship with the human simulation: .....	22
3.4.4 Relationship with the electric energy simulation: .....	25
<b>4 Implementation .....</b>	<b>28</b>
4.1 Implementation Model .....	28
4.2 Thermal Energy Simulation Implementation .....	29
<b>5 Test cases and results .....</b>	<b>32</b>
5.1 Experiment the accuracy of the simulator .....	32
5.1.1 Scenario Explanation:.....	32
5.1.2 Case1: Evaluate the accuracy of the thermal energy simulation .....	34

5.1.3 Case2: Evaluate the accuracy of the energy generation system (Battery, fuel cell).....	37
5.1.4 Case 3: Multi homes simulation: .....	39
5.2 Energy Performance Evaluation .....	42
5.2.1 Improving energy performance .....	42
<b>6 Conclusions.....</b>	<b>48</b>
<b>A Configuration file .....</b>	<b>49</b>
A-1 Configuration of thermal energy network .....	49
A-2 Configuration of energy system .....	50

# Chapter 1

## Introduction

### 1.1 Home network system

At the beginning of the 21<sup>th</sup> century, households are faced with a multitude of issues such as reducing CO<sub>2</sub> output to prevent global warming, energy conservation and security. At the same time, rapid advances in data and communications infrastructure is making it easier than ever for households to connect to the outside world via the Internet. Homes will need to be linked to the outside world to receive safe, pleasant and sound services. Therefore, the home network system or in-home communications infrastructure is expected. This network will enable the interconnection and operation of home appliances and controller from different manufacturers and help to solve the issues above. For example, to satisfy the growing need for energy conservation and load balancing, efficient energy utilization can be achieved through such features as automatic shut-off appliances not in use and automatic shifting of energy consumption in expensive times of the day. For implementing this network, protocols such as UPnP, Echonet were developed. Notably, Echonet (Energy Conservation and Homecare Network) was created to provide the base technology for the development of next-generation home network systems. The outline of the Home Network System (hereby referred as HNS) is described by the figure 1.1

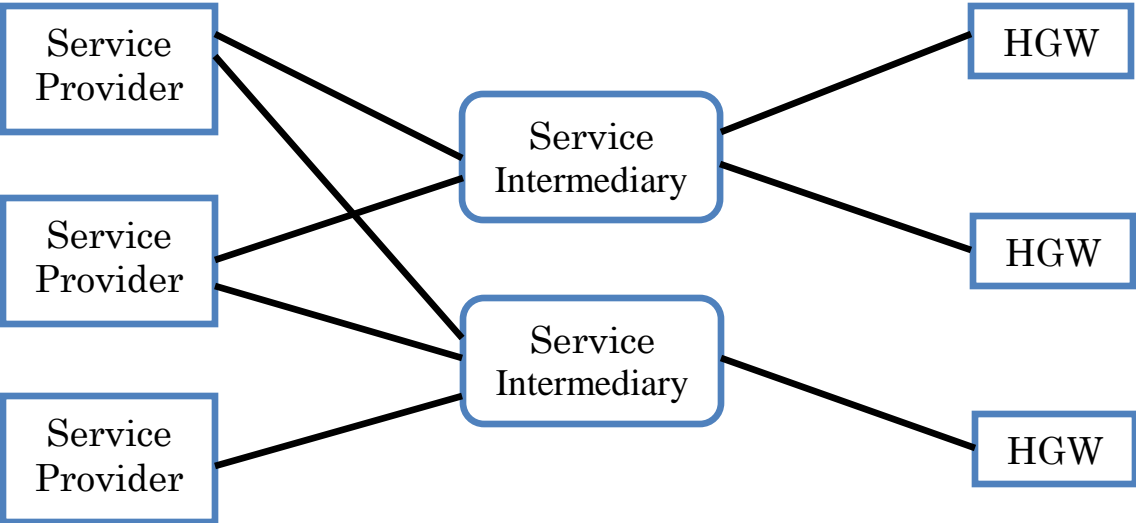

Figure 1.1: Home Network System

A service in the HNS is a service provided to the user that satisfies a specific need. These services may offer a wide area of functionality, such as smart security systems, regulation of energy consumption, context-aware environment and others.

The HNS uses the Service Intermediary (SI) model to provide service to the user. In the SI model, there are three main entities:

- ❖ The back-end Service Provider (SP). This is the actual provider of a specific service. The SP designs services that will be provided to the HNS, the final deployment target
- ❖ The Home Gateway (HGW). The HGW acts as the gateway of the HNS to the outside world. Services can be executed directly on the HGW hardware. Moreover, the HGW acts as a software bridge, capable of controlling or passing command to other devices in the HNS.
- ❖ The Service Intermediary (SI). The SI acts as an intermediary between the SP and the HGW. In this model, the HGW does not contact the SP to have access to a service. Instead, the SI aggregates services from various SPs and present them to the user. The user makes a contract with the SI to have access to the services of the various SPs.

## 1.2 Target of this research

Nowadays, co-generation energy systems such as fuel cell (FC) that produces both power energy and thermal energy, is being applied in practice. With the goal of seeking energy efficiency, this paper aims to develop a smart house simulator capable of evaluating both power energy and thermal energy in the smart house. This research will add a thermal energy simulation model to the existing home network simulator, not only to reflect power energy and thermal energy consumptions but also to evaluate energy efficiency.

The existing home network simulator includes four main simulation components: human, environment, home appliance and power energy. These components exist some interactive relationships each other. The added thermal energy simulator simulates the thermal system in the smart house and creates links with the rest. This simulator implements water pipe system, energy supply system like tank, FC, battery, etc., and some appliances such as bathtub, water taps, etc.

## 1.3 Structure of this document

In chapter 2 we will explain the background regarding the home network simulator and its components. We will proceed to describe architectural model for the home network simulator and then describe what is simulated in each component. We will finish chapter 2 by describing in-depth the model of the electric energy simulation.

In chapter 3 we will discuss the thermal energy system in the smart house. Then we will proceed to give the model of the thermal energy simulation. Namely, we will talk about the simulation of the water pipe system, energy supply system like tank, FC, battery. We will then proceed to describe the relationship between this simulation and the other components.

In chapter 4 we will give an overview of the implementing structure model we developed, and describe the way to implement the thermal energy simulation, as well as the

interaction with the existing home network simulator. We will proceed to provide some implementation details about the system.

In chapter 5 we will present some scenario setups along with the results attained. The scenarios will demonstrate the operation of the simulation system.

Finally in chapter 6 we present the final conclusion and remarks.

# Chapter 2

## Related Works

### 2.1 Home network simulation

In this section we will discuss the existing home network simulation. The simulation has been implemented with four main simulation components: environment, electric energy, human, appliance [1]. The combination of these four components forms the house simulation (known as the home network simulation). The relationships of the components are denoted by figure 2.1.

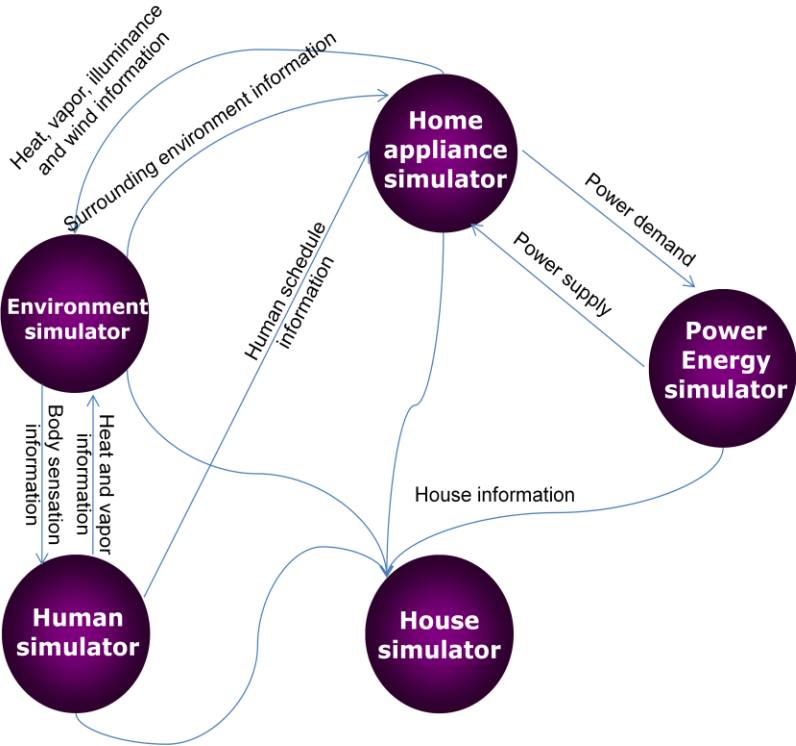

Figure 2.1: The existing home network simulation

- ❖ **House simulation:** describes a structure of house such as: number of rooms, position of rooms, roof, wall, door, curtain, sash, awning and others. It manages these objects based on some information for each object like size, direction and material. Besides that, it is a general simulation that contains the four remaining components. These components will refer the house information in the house simulation.

- ❖ **Environment simulation:** defines interior environment of each room and outside environment of house. The interior environment of each room is different from others depending on some effects of human and appliances. It simulates the temperature, humidity, illumination and pressure environment in each room. The environment will change over time regarding the effects of human, appliances and surrounding environment like sun light. The outside environment of house defines the environment around the house such as outside temperature, sunlight illumination and others based on getting the weather data. This simulation was implemented by the Computational Fluid Dynamics (referred as CFD). The simulator ensures that the information of the environment simulation is exact and this environment information change regarding the effect of the other components.
- ❖ **Human simulation:** the human simulation model defines family structure, family type and family profile as well as the human information like habit, desire, daily schedule. Based on this information, the activity decision model will decide the activity of the human at each time. The model makes a decision by using statistic and probability method. In order to making a decision, the simulation needs to collect the habit, desire and daily schedule data, as well as to classify the activity of the human such as sleep, eat, work and other. Combining these decided activities will make a daily general schedule for that human. The daily schedule of the human will be described in the figure 2.3

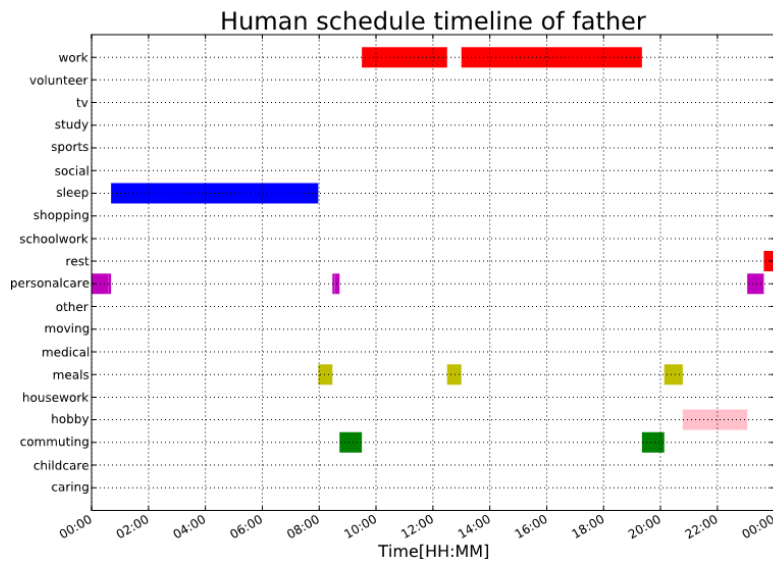

Figure 2.2: Human schedule

Moreover, each activity was divided in many actions. For example, with sleeping activity, the human needs some actions like move, clean up light, search for room, check for another human in room or not.



- ❖ **Appliance simulation:** defines appliance information in house regarding Echonet standard. Because the information and behavior of each appliance is different from others, a mathematical formula will be applied for each appliance to express its behavior. For example, the mathematical model expresses the behavior of the air conditioner. The model will calculate the power consumption of each human setup respectively, as well as thermal energy generated around room. These appliances are controlled regarding the activity of the human.
- ❖ **Electric energy simulation:** defines electric energy system in house consists of distribution board, circuit and power plug. Each object contains the information concerns about its position in the house, maximum and minimum power supply, which appliances connect to it and other. The simulation was designed by the tree structure that will be described in the figure 2.5

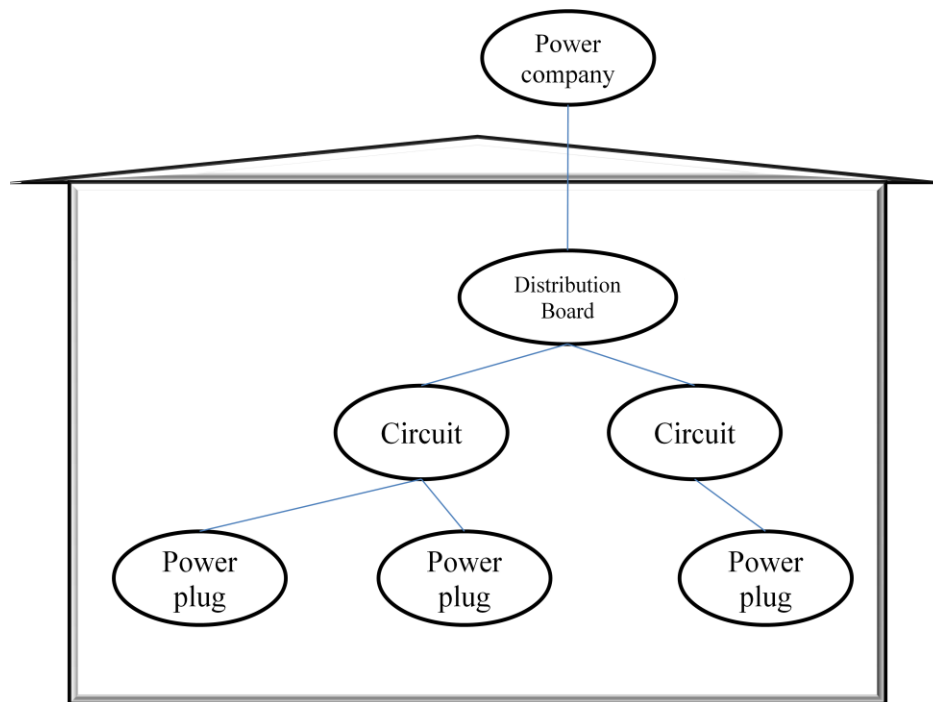

Figure 2.3: The tree structure of electric energy simulation

# Chapter 3

## Thermal energy simulation

In this section we will discuss the thermal energy system in house. Then we will propose the model of this system, as well as how to integrate it to the existing home network simulator.

### 3.1 Energy System in the house

At the present, Energy System research emphasizes all aspects of electrical energy, thermal energy, innovation in energy generation and delivery, alternative resources, and efficient devices. Notably, alternative resources are being researched and developed such as solar cell, fuel cell, wind power, solar collector panel that are described in the figure 3.1.

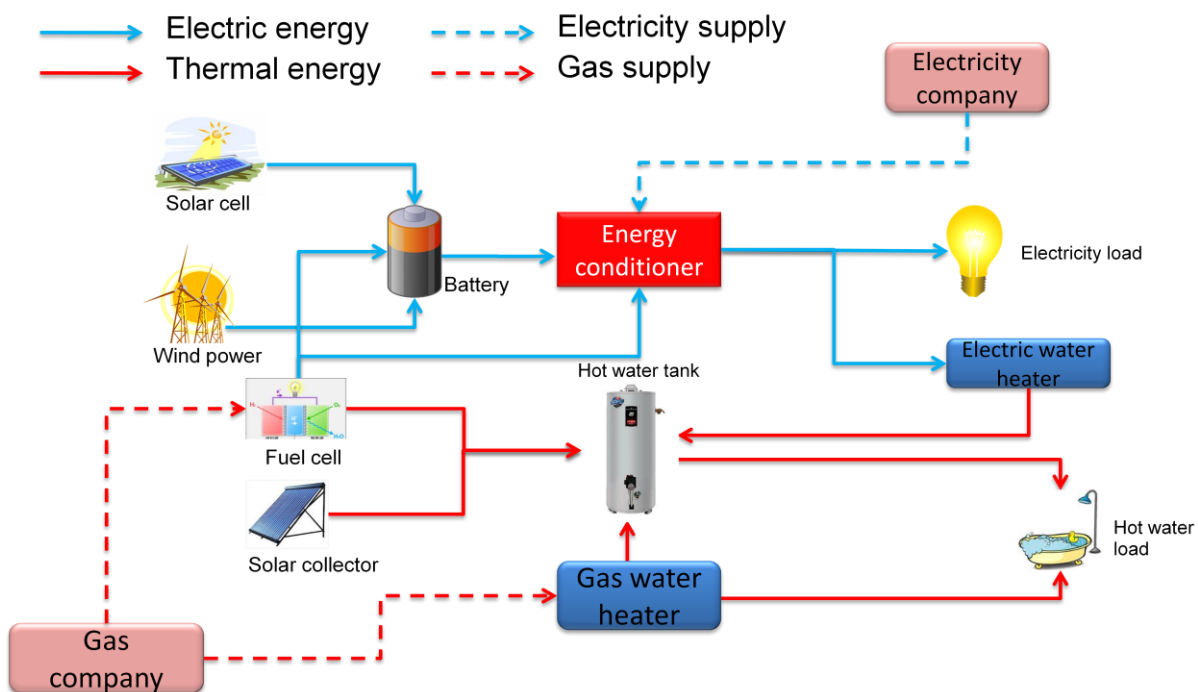

Figure 3.1: Energy system in the house

The figure shows the interaction of energy generation systems that guarantee for saving energy and energy efficiency. Multiple supply lines allow you to use energy effectively regarding the weather conditions. With a sunny day, solar systems are a low maintenance highly effective way to fulfill your electric and heating needs. Solar cell known as photovoltaic solar takes the power of the sun and converts it to the usable electricity for your home or business. Moreover, the solar collector panel meets your needs as warm as you wish while saving up to 50% on your electric bill. Meanwhile with rainy day, we can fulfill the needs by auxiliary devices like water heater or electric company, as well as using fuel cell. Fuel cell systems have received increasing

attention in recent years as a viable alternative for meeting the electrical and thermal needs of buildings. Beside that, redundant energy that is produced by these next generation energy systems can be used to charge the battery. The problem is how the energy flow moves in the energy system and how much energy transferred. Therefore, we need an energy simulation system that can describe the transferring energy flow, the behavior of each next generation energy system, and then we can evaluate the energy efficiency and find out the saving energy way. However, we not only simulate the energy system but we also need to simulate how the hot water is supplied to the user.

### 3.2 Hot water pipe system

In this section we will discuss how the hot water is supplied to the user and how to calculate the hot water supplied amount. In the house, the hot water circulates to supply to the appliances through the hot water pipe system like the figure 3.2 below.

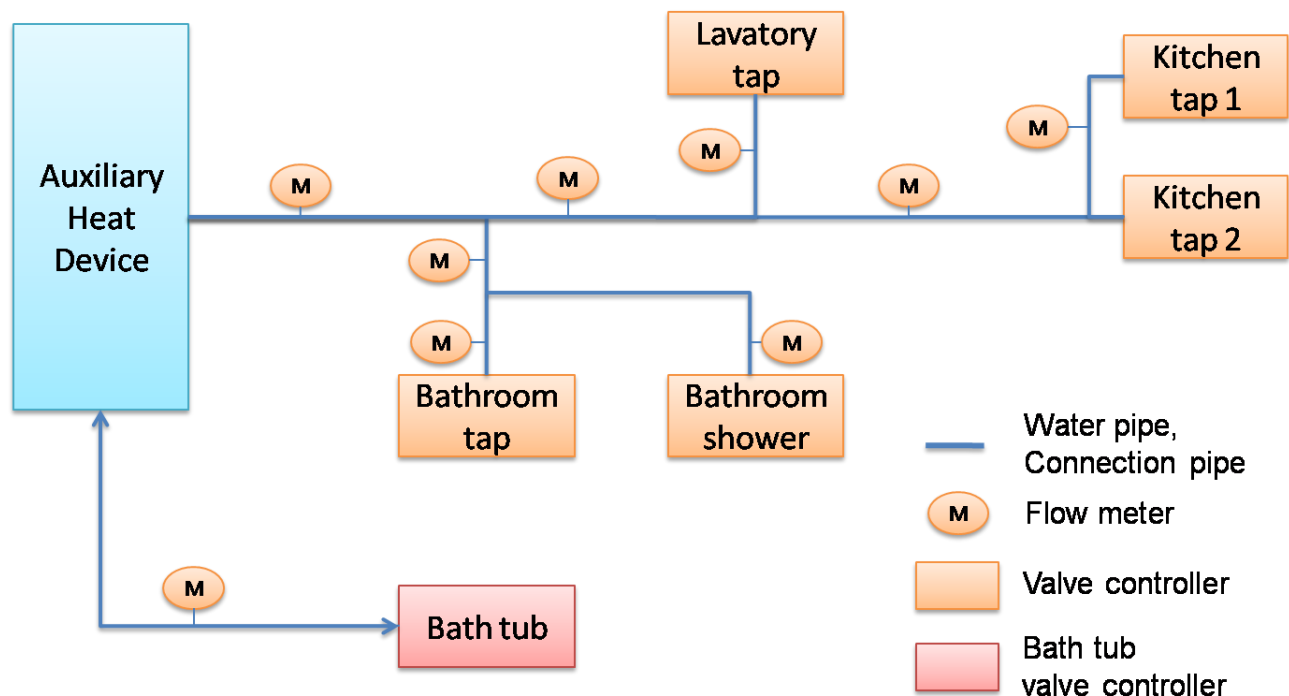

Figure 3.2: Hot water pipe system in home

The figure shows the relationship of water pipe, terminal appliance, flow meter appliance and hot water supplied device.

- ❖ **Water pipe & Connection pipe:** circulates the hot water to terminal device like tap, shower and bathtub. Two pipes above connect each other to form connection pipe. The connection pipe and water pipe have the same properties such as diameter of pipe, water flow rate and other.

- ❖ **Terminal appliance:** receives supplied hot water and provide to the user such as shower, valve controller, bathtub, remote control and other. The supplied water from the water pipe to the tap and the shower through valve controller. This device controls the amount of hot water that will be provided to the user. We will discuss the function and properties of these appliances in the next section.
- ❖ **Flow meter appliance:** measures water flow rate at each pipe. Therefore, they will be attached to each pipe.
- ❖ **Hot water supplied device:** provide the hot water regarding to the demand such as hot water tank, auxiliary heat device.

Based on the structure of the hot water pipe system and the Energy System in the house, we will propose the thermal energy simulation model that will be described in the next section.

### 3.3 Thermal Energy Simulation Model

In this section we will discuss the proposed thermal energy simulation model. Based on the knowledge of the hot water pipe system and the energy system we propose the simulation model like the figure 3.3 below

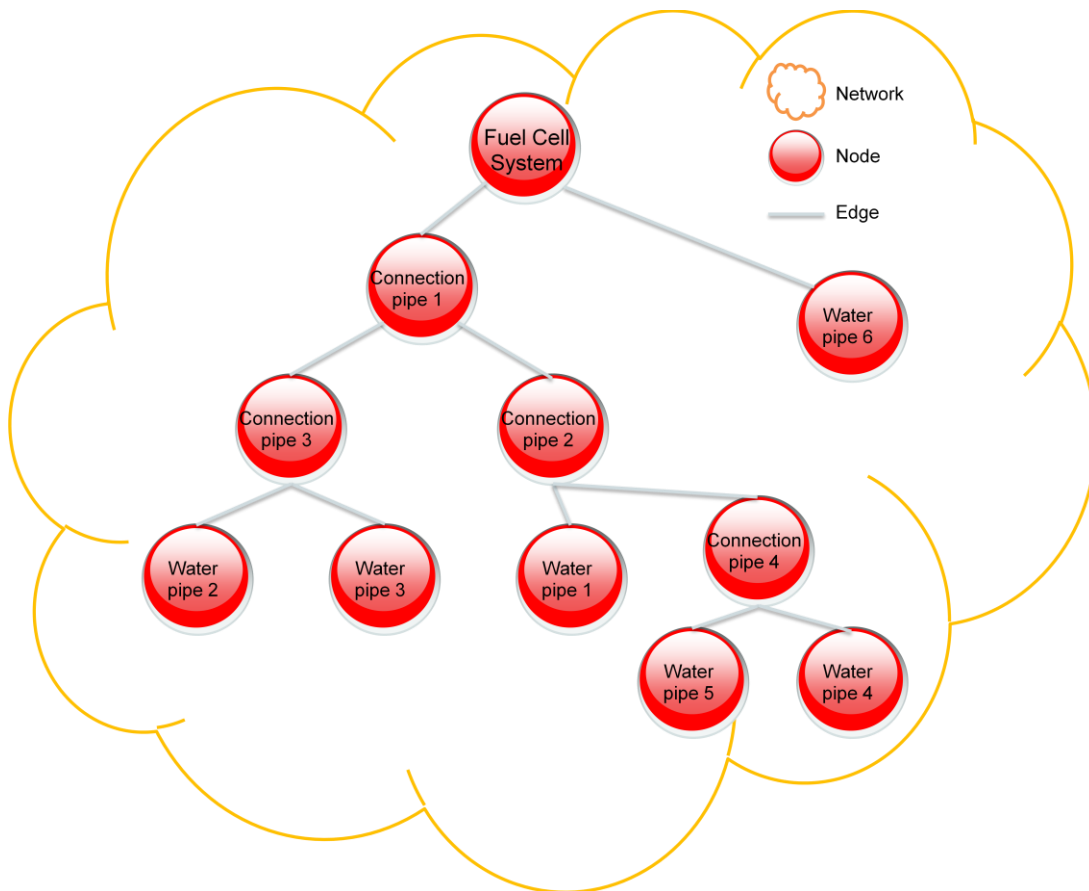

Figure 3.3: Thermal energy simulation model

This proposed simulation model simulates the thermal energy system network in the house. Actually, it is thermal energy network that consists of network, node and edge.

- ❖ **Network:** aggregates nodes, edges and manage the transfer data between them.
- ❖ **Node:** Each node has a specific function. Each node communicates with another through sending a message to the edge connects them.
- ❖ **Edge:** creates communication of nodes, receives a message and sends it to a target node.

The model uses the tree structure to simulate the thermal energy system. Firstly, the leaf nodes like water pipe node will receive a hot water demand message from the appliance component, and then send it to the upper connection pipe node. This connection pipe node will aggregate all demand messages, and send a demand message to the upper until a demand message comes to the fuel cell node. The fuel cell node will analyze these demand messages regarding the status of the fuel cell system. After that, it will send to that requested node a supply messages that contains hot water information. This supply messages will continue to be sent to the leaf node. The leaf node that receives the supply message will provide hot water to the requested appliance in the appliance network.

### 3.3.1 Fuel cell system:

In this section, we will explain the fuel cell node in detail. A fuel cell system consists of 3 three main elements: Fuel cell, hot water tank, auxiliary heat device that is connected to the hot water pipe system directly. The figure 3.4 describes the structure of the fuel cell system.

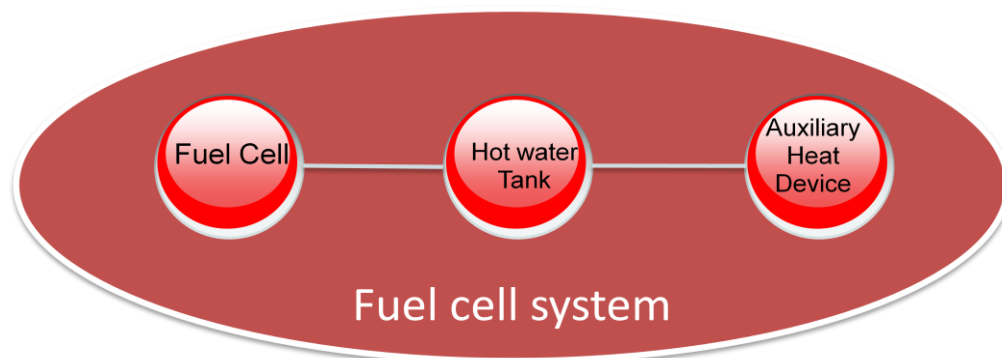

Figure 3.4: The structure of the Fuel Cell System

- ❖ **Fuel cell:** is a device that converts the chemical energy from a fuel into electricity through a chemical reaction with oxygen or another oxidizing agent. Fuel cells are different from batteries in that they require a constant source of fuel and oxygen to run, but they can produce electricity continually for as long as these inputs are supplied. There are many types of fuel cells, but they all consist of an anode (negative side), a cathode (positive side) and an electrolyte that allows charges to move between the two

sides of the fuel cell as in the figure 3.5

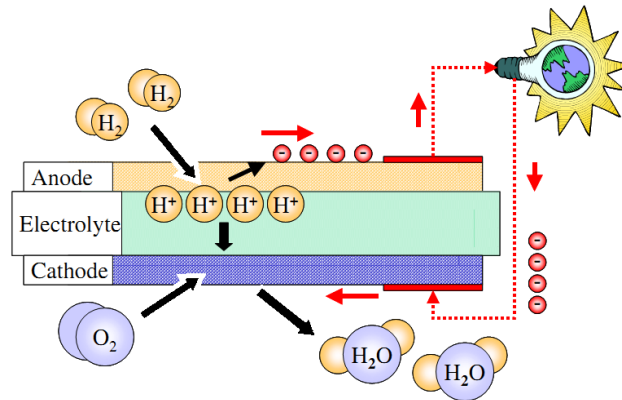

Figure 3.5: The principle of the fuel cell

Electrons are drawn from the anode to the cathode through an external circuit, producing direct current electricity. As the main difference among fuel cell types is the electrolyte, fuel cells are classified by the type of electrolyte they use. Fuel cells come in a variety of sizes. Individual fuel cells produce very small amounts of electricity, about 0.7 volts, so cells are "stacked". In addition to electricity, fuel cells produce water, heat and, depending on the fuel source, very small amounts of nitrogen dioxide and other emissions. A general fuel cell system is comprised of:

- **Fuel processor:** is used to convert a hydrocarbon fuel such as natural gas, into a stream containing hydrogen that may be oxidized in the fuel cell stack
- **Fuel cell stack:** a collection of anode–electrolyte–cathode structures, in which electrochemical reactions occur. The chemical energy contained in hydrogen is converted into electricity.
- **Heat recovery equipment:** The fuel and water must be heated to temperatures over 700 °C before they can be reacted in the reformer. Conversely, the hydrogen-rich reformat produced by the fuel processor must be simultaneously cooled to the fuel cell stack operating temperature before it can be reacted in the fuel cell stack. The system's efficiency can be greatly increased if the required heating and cooling is accomplished by transferring heat from the streams requiring cooling to the streams requiring heating. In fuel cell systems, this is accomplished using a network of heat exchangers.

The mathematical formula expresses the behavior of fuel cell simply:

$$\dot{W}_{elec.} = \eta_{stack} \Delta H_{stack}$$

$$\dot{Q}_{stack} = \Delta H_{stack} - \dot{W}_{elec.}$$

- $\Delta H_{stack}$ : the total amount of chemical energy released in the fuel cell stack.
- $\dot{W}_{elec.}$ : the amount of electrical work produced by the fuel cell stack.
- $\eta_{stack}$ : the overall efficiency.

- $Q_{stack}$  :The amount of heat produced by the fuel cell stack.
- ❖ **Hot water tank:** (also thermal storage tank, hot water thermal storage unit, heat storage tank, hot water cylinder) is a water tank that is used for storing hot water for space heating or domestic use. A heavily insulated tank can retain heat for days. Hot water tanks may have a built-in gas or oil burner system, or electric immersion heaters, or may use an external heat exchanger to heat water from another energy source such as district heating, wood-burning stove, or a district heating system. Water heaters for washing, bathing, or laundry have thermostat controls to regulate the temperature, in the range of 40 to 60°C, and are connected to the domestic cold water supply.

A fuel cell configuration based on natural convection of water between the fuel cell and the hot water tank. The water inside the fuel cell loop is heated up by the emission of the fuel cell while the fuel cell produces electricity. Figure 3.6 depicts a simplified model of the fuel cell configuration.

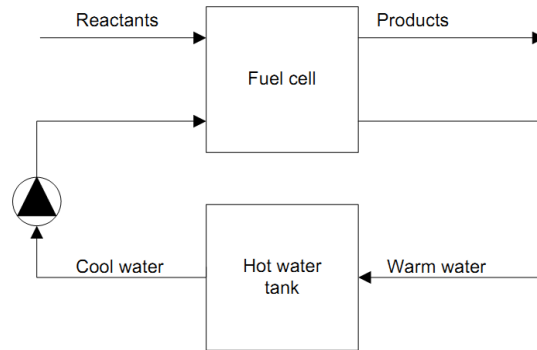

Figure 3.6: simplified model of the fuel cell configuration

Because of tank water would be relatively cold and the status of tank will change regarding the hot water demand from the user, we need a mathematical model to simulate the behavior of the hot water tank:

$$m_s * C_P * \frac{dT_s}{dt} = Q_C - Q_L - UA * (T_s - T_a)$$

- $m_s$  mass of water in the storage tank, kg
- $C_P$  heat capacity of water, J/ (kg K)
- $T_s$  the instantaneous tank temperature
- $Q_C$  heat addition from FC, W
- $Q_L$  heat removal from the storage tank to the utility, W
- $U$  overall heat transfer coefficient of the tank, W/ (m<sup>2</sup> K)
- $A$  the storage tank area, m<sup>2</sup>
- $T_a$  the ambient temperature, K
- $T_{co}$  outlet temperature from heat recovery device, K
- $T_{ci}$  inlet temperature to heat recovery device, K

- ❖ **Auxiliary heat device:** is installed in an area close to a hot water tank. This water heater is installed into the existing water line and serves to heat water flowing through the water line. It comprises a cylindrical shaped water tank that is encompassed within an oblong case. The cylindrical shaped water tank has a water input and a water output line. An electrical heating element is used to heat water within the cylindrical water tank and the temperature of the hot water is controlled by a temperature control switch. When the hot water tank can not response a required hot water temperature of the user. The fuel cell system will use the auxiliary heat device as a thermal energy source to heat water above its required temperature. Due to the placement of the auxiliary water heater, the amount of time it takes to receive hot water at a faucet is reduced and thereby reduces the amount of water that is wasted waiting for hot water. In this simulation model, the auxiliary heat device will be connected directly to the domestic water pipe system. Using the auxiliary heat device for heating water depending on the water temperature in the hot water tank is large enough to response a requested hot water temperature of the user or not.

### 3.3.2 Behavior of FC system:

This section will give you an overview of the fuel cell system's operation. Generally, it consists of four behaviors:

- ❖ **Heating water behavior:** when the fuel cell system produces electricity to supply the domestic demand, it will use the heat emissions from chemical reaction to heating water within the hot water tank. The figure 3.7 will depict this behavior.

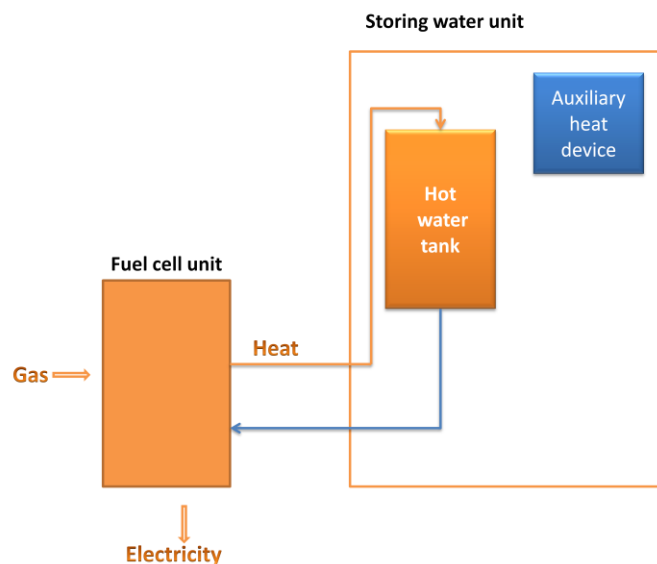

Figure 3.7: Heating water behavior

- ❖ **Supplying water behavior:** Using hot water within the hot water tank to supply the user. When the temperature of the hot water in the tank is not large enough to provide the user, the auxiliary heat device will heat the hot water to its requested temperature. The figure 3.8 will depict this behavior.



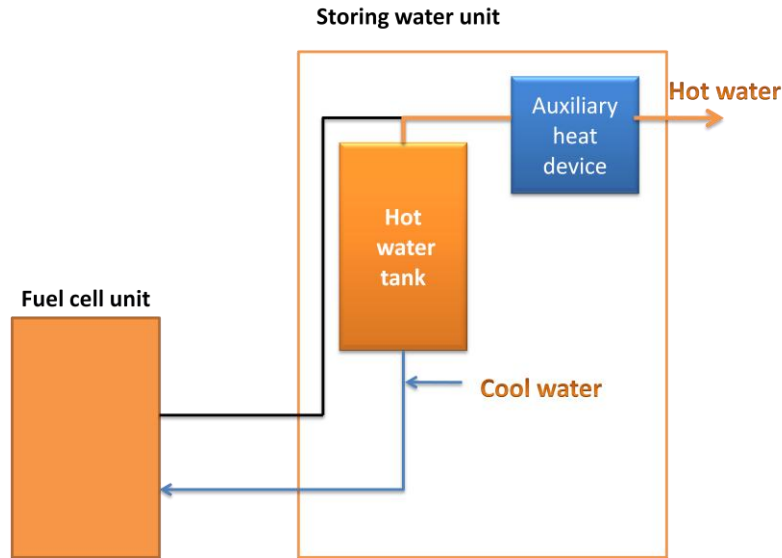

Figure 3.8: Supplying water behavior

- ❖ **Space heating behavior:** when the fuel cell system produces electricity to supply the domestic demand, it will use the heat emissions to heat air for supplying space heating such as air conditioner. When heat emissions are not large enough to supply, the auxiliary heat device will be used as a thermal energy source. The figure 3.9 will depict this behavior.

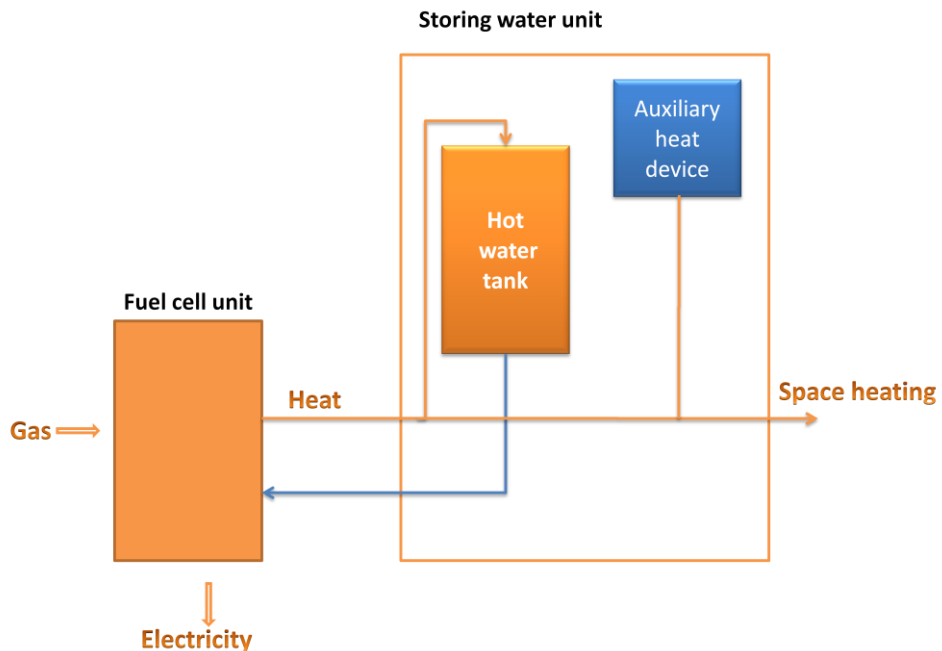

Figure 3.9: Space heating behavior

- ❖ **Warming water behavior:** When the tank supplies water to bath tub, the hot water of the bath tub will be cold relatively by convection. Therefore, we need a warming process that warming the water of the bathtub to its desired temperature. The warming process will use the auxiliary heat device as a thermal energy source for warming. The figure 3.10 will depict this behavior.

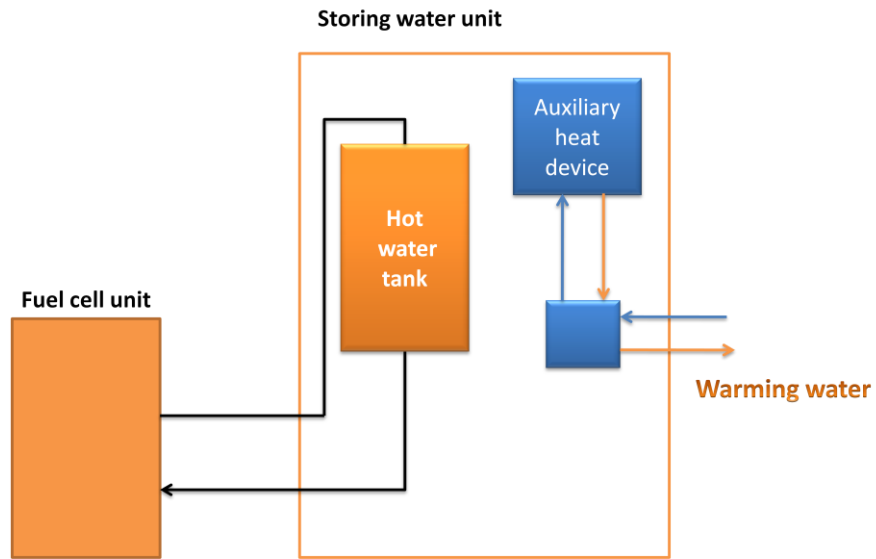

Figure 3.10 Warming water behavior

### 3.4 Relationships between simulation components

In this section we will discuss the relationships between thermal simulation components and other components. When we add a new simulation in the house simulation, we need to integrate it to the entire system such as how it will talk with other components. The figure 3.11 will give an overview of the entirely house simulation.

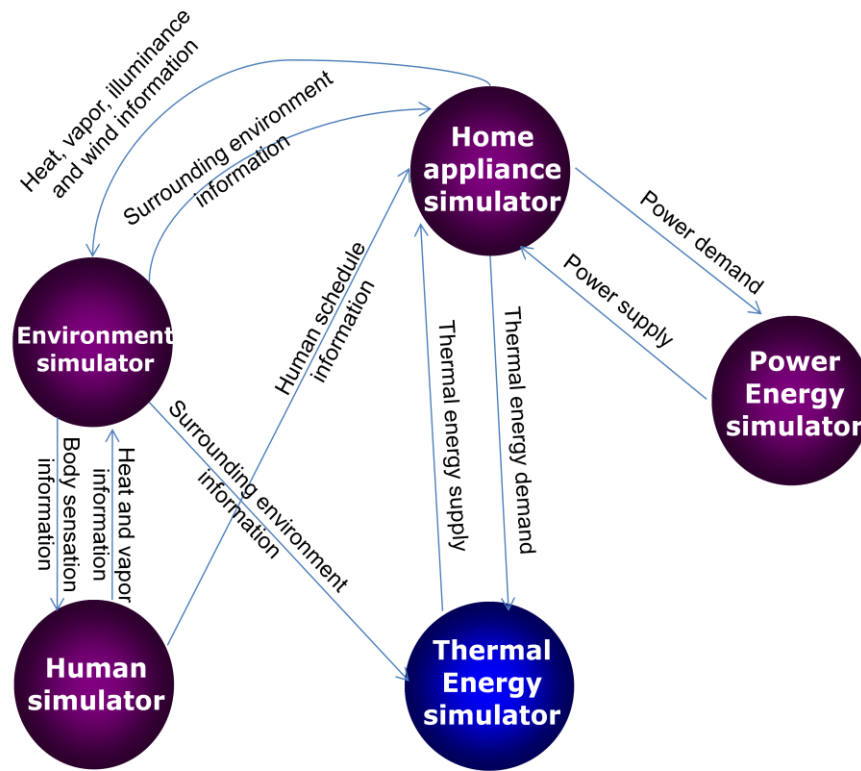

Figure 3.11: The home network simulation that consists of thermal simulation

#### 3.4.1 Relationship with the appliance simulation

As you know, the appliance simulation defines appliance information in house regarding Echonet standard. Because the information and behavior of each appliance is different from others, a mathematical formula will be applied for each appliance to express its behavior.

- ❖ **Valve controller:** are valves used to control conditions such as liquid level by fully or partially opening or closing in response to signals received from controllers that compare a "setpoint" to a "process variable" whose value is provided by sensors that monitor changes in such conditions. The opening or closing of control valves is usually done automatically. Positioners are used to control the opening or closing of the actuator based on electric or pneumatic signals. This device will control hot water level to the appliances in response to the demand message of the appliances.

- ❖ **Remote control device:** consists of remote control display and valve controller. The remote control display will interact and receive control from the user such as setting up desired hot water temperature or setting up automatic mode to fulfill hot water in bath tub. This device also controls valve controller of the bath tub tap in the bathroom. When the user wants to bath in the bath tub, the user will adjust the remote control display. Then, this device will fulfill water within the bathtub by controlling the valve controller. However, this device also is used to control some conditions such as water temperature for cooking or personal care. Of course, it can not control valve controller for these activities.

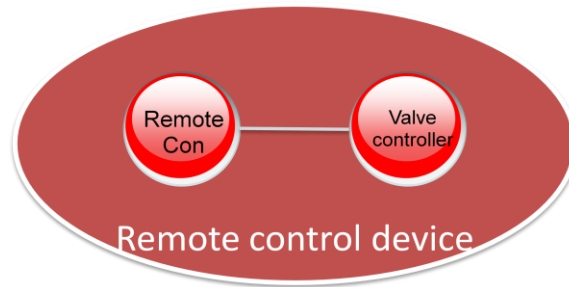

Figure 3.12: The structure of remote control device

This table below depicts some properties of this device.

Operation status	Desired bathtub water supply temperature
Valve volume level	Desired hot water supply temperature
Bathtub bumping status	Desired bathtub volume
Bathtub cooling status	Bathtub warming status

- ❖ **Flow meter:** is a device that measures volumetric flow rate of a fluid traveling through a tube. The volumetric flow rate is the volume of the fluid traveling past a fixed point per unit time.
- ❖ **Relationship:** These appliances are controlled regarding the activity of the human. Therefore, the human will make an energy demand through the appliance simulation.

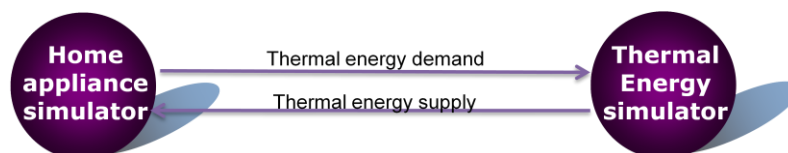

Figure 3.13: The relationship between appliance simulator and thermal energy simulator

Firstly the appliance simulator will send a thermal energy demand message to the thermal energy simulator when the appliances like tap, shower have needs to use hot water. The thermal energy simulator receives the message and then responses it by a thermal energy supply message regarding the status of the thermal energy system. We will give 2 examples to depict this relationship in detail.

In the first example, we discuss how to use hot water at kitchen for cooking. When the user wants to use hot water for cooking, he or she can adjust remote control device that put at the kitchen or bathroom usually. After adjusting, this device will send a control message that contains some control information like desired hot water temperature to the fuel cell system. Fuel cell system will save this information and supply the water in response to that adjustment of the user. Then the user only controls valve controller in order to flow water out. In the figure below, we see two network and their interactive relationships. In order to know used water volume, a flow meter will be put at each water pipe. In the figure, we see a line that connects flow meter node and water pine node to contact each other.

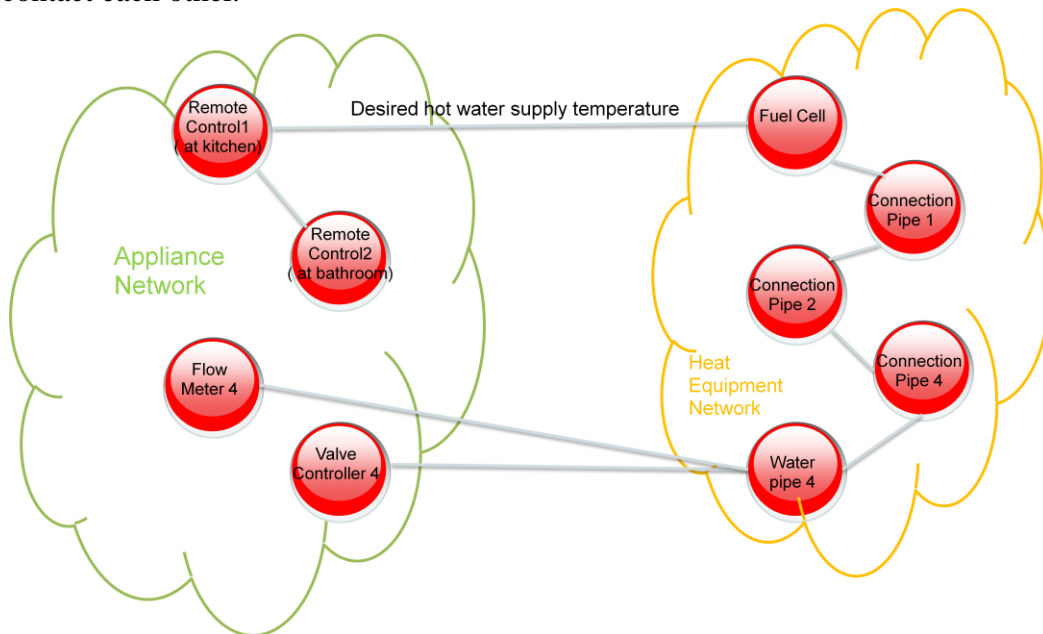

Figure 3.14: Example of using hot water at kitchen

In the second example, we discuss how to use hot water at bathroom for bathing. When the user wants to use hot water for bathing, he or she can adjust remote control device that put at the bathroom or kitchen usually. After adjusting, this device will send a control message that contains some control information like desired hot water temperature to the fuel cell system. Fuel cell system will save this information and supply the water in response to that adjustment of the user. Then the remote control device continues to control valve controller that is used to control liquid level of the bathtub in order to flow water out to the bathtub automatically. The valve controller will be stopped when the water amount within the bathtub equal to the designed volume water that is set up by the remote control display.

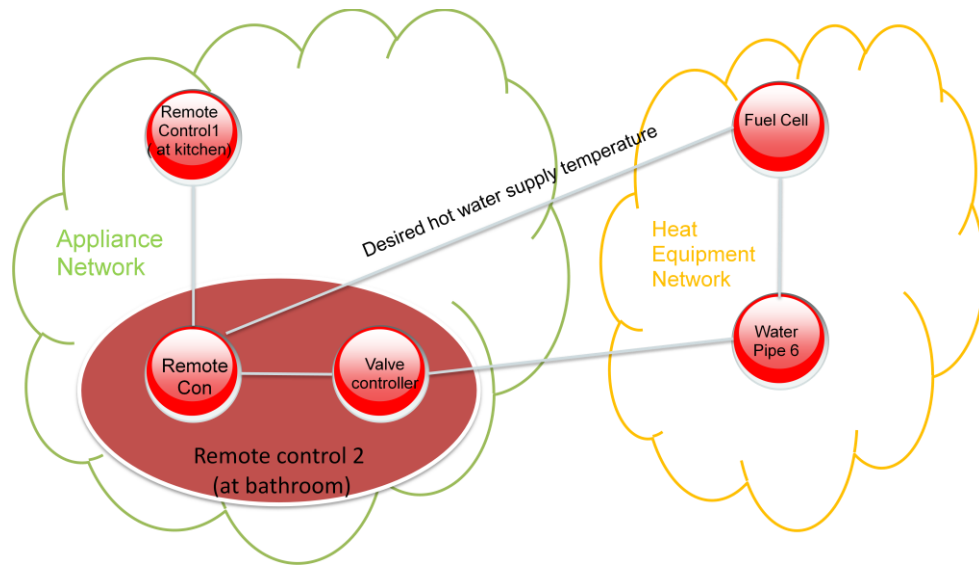

Figure 3.15: Example of using hot water at bathroom for bathing

### 3.4.2 Relationship with the environment simulation:

As you know, the environment simulator defines interior environment of each room and outside environment of house. It simulates the temperature, humidity, illumination and pressure environment in each room. The environment will change over time regarding the effects of human, appliances and surrounding environment like sun light. In order to simulate the status of the hot water tank that changes regarding the environment conditions, it is necessary to make a relationship between them.

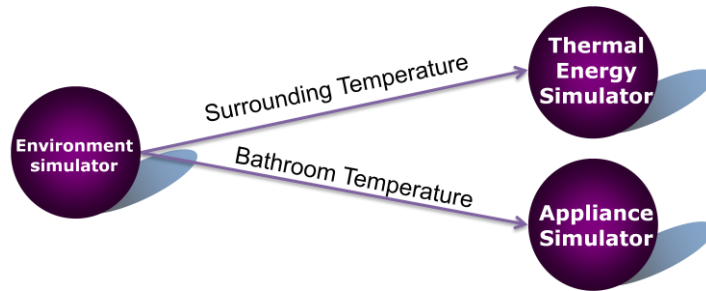

Figure 3.16: The relationship between environment simulator and thermal energy simulator

In the thermal energy simulator, it is necessary to simulate the change of the hot water tank like hot water temperature in tank, convection heat and others. Therefore, it will connect with the environment to get surrounding temperature, then it use this temperature information for simulating the change of the hot water tank. Beside that, when we simulates the appliance simulator, some appliances have specific behavior that required a mathematical models to express it. These mathematical models required the room temperature at each time. For example, the bathtub valve controller simulates the cooling process of the hot water within the bathtub because of convections. The cooling process of the hot water will change regarding the bathroom temperature. The hot water temperature will decrease rapidly if the ambient temperature as low.

### 3.4.3 Relationship with the human simulation:

As you known, the human simulator defines human, family structure, family type and family profile as well as the human information like habit, desire, daily schedule. Based on this information, the activity decision model will decide the activity of the human at each time. And depending on activity, the human simulator will interact and control related appliances in the appliance simulator. In this section we will focus on some human activity that relate to thermal energy simulation.

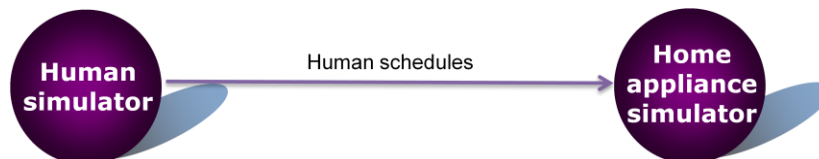

Figure 3.16: The relationship between human simulator and appliance simulator

The figure let us see that the human simulator will control appliances based on the human schedule. The human schedule consists of many activities that change over time. Each activity will interact with its respective appliance. We will divide some activities that use thermal energy. Four categories to describe the different types of loads are defined:

- ❖ **Category A:** short load (washing hands, brush tooth, personal care, etc.)
- ❖ **Category B:** medium load (dish-washer, cooking)
- ❖ **Category C:** bath (using bathtub)
- ❖ **Category D:** shower

We have assumptions made for every specific category for the mean flow rate ( $\dot{V}$ ), the duration of one load (duration), the nr. of incidences per day (inc/day) and the statistical distribution of different flow rates ( $\sigma$ ).

	cat A: short load	cat B: medium load	cat C: bath	cat D: shower	Sum
$\dot{V}$ in l/min	1	6	14	8	
duration in min	1	1	10	5	
inc/day	28	12	0.143 (once a week)	2	
$\sigma$	2	2	2	2	
vol/load in l	1	6	140	40	
vol/day in l	28	72	20	80	200
portion	0.14	0.36	0.10	0.40	1

Figure 3.17: Assumptions and derived quantities for the load profile

Based on this assumption the human simulator will control the related appliances like valve controller in order to demand hot water amount corresponding to each activity in each category. The below figure depict the one day schedule of the father. The red line denotes some activities that relate to thermal energy simulation.



## Mother schedule

00:00 06:13 sleep: sleep  
06:13 07:13 housework: cooking  
07:13 07:18 personalcare: brush\_tooth  
07:18 07:28 personalcare: personal\_care  
07:28 07:58 meals: breakfast  
07:58 08:28 housework: washing  
08:28 09:28 housework: cleaning  
09:28 11:20 tv: tv  
11:20 12:00 housework: cooking  
12:00 12:30 meals: lunch  
12:30 12:35 personalcare: brush\_tooth  
12:35 12:45 personalcare: personal\_care  
12:45 14:00 tv: tv  
14:00 16:05 social: social  
16:05 16:48 tv: tv  
16:48 17:30 shopping: shopping  
17:30 18:30 housework: cooking  
18:30 19:05 personalcare: bathing  
19:05 19:43 meals: dinner  
19:43 20:03 housework: houseworks  
20:03 21:58 tv: tv  
21:58 22:03 personalcare: brush\_tooth  
22:03 23:30 tv: tv  
23:30 00:00 sleep: sleep

Figure 3.18: The day life schedule of mother

### 3.4.4 Relationship with the electric energy simulation:

In the past, the electric energy simulator uses the power that is provided by the power company. In this thesis, we also implement the next generation energy system such as fuel cell, battery. Therefore it is necessary to make a relationship between the next generation energy system and the electric energy simulation. The electric energy simulation defines electric energy system in house consists of distribution board, circuit and power plug. The distribution board will be connected to the fuel cell and the battery for receiving the energy. Depending on the status of fuel cell and battery, the distribution board will be received supply power or not. The figure below depicts the relationship between the thermal energy simulator and electric energy simulator.

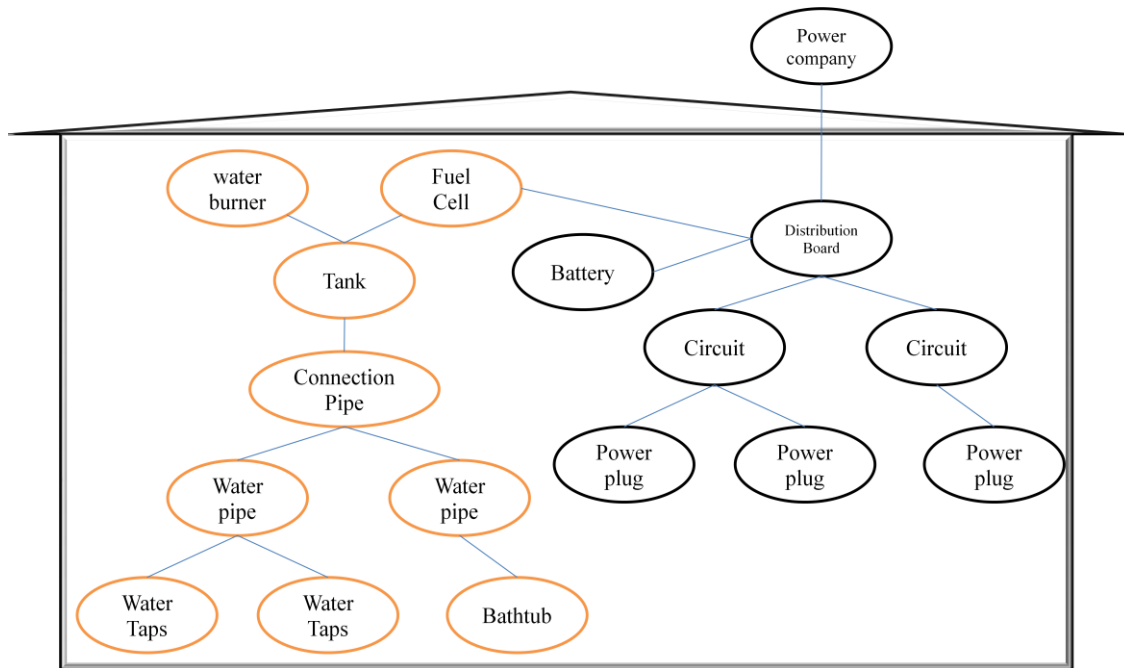

Figure 3.19: The relationship of electric simulator and thermal energy simulator

In the figure, we see that the fuel cell is connected to both thermal energy simulator and the electric energy simulator. When we integrate the next generation energy system to the energy simulator, we can evaluate the energy efficiency regarding the distribution of using which the energy system. Beside that, we can save the energy in the battery and use them when black out or peak time. Because the next generation energy system creates a DC electric power, they can not connect to the distribution board directly. We can use the power conditioner to control and transfer power. We will discuss more clearly about battery and power conditioner.

- ❖ **Battery:** device that converts chemical energy into electrical energy, consisting of a group of electric cells that are connected to act as a source of direct current. The term is also now commonly used for a single cell, such as the alkaline dry cell used in flashlights and portable tape players, but strictly speaking batteries are made up of connected cells encased in a container and fitted with terminals to provide a source of direct electric current at a given voltage. A cell consists of two dissimilar substances, a

positive electrode and a negative electrode, that conduct electricity, and a third substance, an electrolyte, that acts chemically on the electrodes. The two electrodes are connected by an external circuit (e.g., a piece of copper wire); the electrolyte functions as an ionic conductor for the transfer of the electrons between the electrodes. The voltage, or electromotive force, depends on the chemical properties of the substances used, but is not affected by the size of the electrodes or the amount of electrolyte. Batteries also can be generally divided into two main types-rechargeable and non rechargeable, or disposable. Disposable batteries, also called primary cells, can be used until the chemical changes that induce the electrical current supply are complete, at which point the battery is discarded. Disposable batteries are most commonly used in smaller, portable devices that are only used intermittently or at a large distance from an alternative power source or have a low current drain. Rechargeable batteries, also called secondary cells, can be reused after being drained. This is done by applying an external electrical current, which causes the chemical changes that occur in use to be reversed. The external devices that supply the appropriate current are called chargers or rechargers. The table below depicts some properties of the battery that will be implemented in this simulation.

Operation status (0x80)	Remaining power amount (0xE3)
Installation location (0x81)	Voltage Input
Battery volume (0xD1)	Voltage output
Charging mode (0xDA)	Charging/ generating power amount (0xE1)

In this simulation, we implement a battery that consists of some information such as input voltage, output voltage, storage volume, maximum supplied power and efficiency. Because the battery can not connect to supply the domestic needs directly, we use a power conditioner for transferring DC power to AC power and inversely.

- ❖ **Power conditioner:** is designed to maintain the mains voltage constant all the time. Their electronic amplifier controls will electronically correct the mains voltage should the mains voltage goes high or low. They are characterized by the high efficiency and are completely unaffected by power factor, load and frequency variations. They can withstand high instantaneous overloads and does not create any magnetic interference. Compact in size, quiet in operation, these conditioners are very suitable for indoor use and can be located near to equipment without causing any magnetic disturbances to the load equipment. It consists of some standard functions like Input Circuit Breaker, Over/low Voltage Protection, Bypass Control Switch, Voltmeter and Converter. We will concentrate on converting function. It is an electrical function that converts alternating current (AC) to direct current (DC) and inversely. We have a simply formula for the converting process.

$$\text{電力変換効率}\eta_{ac} = P_{ac} / P_{dc} * 100 [\%]$$

$$P_{dc} = V_{dc} \times I_{dc} \quad P_{ac} = V_{ac} \times I_{ac}$$

The formula calculates the relationship of AC current and DC current based on converting efficiency parameter. Because the fuel cell system generates a direct current, this power conditioner is used to convert DC current of FC to AC current for supplying.

The figure below depicts the total model of the electric energy simulator. Firstly, the leaf nodes (circuits) will receive power demand from the appliance and then send them to the upper node (distribution board). This board will decide to get supplied power from FC or battery or the power company. We will discuss which energy source will be used for supplying in the energy performance evaluation section. In the battery side, it can become a power load appliance or a energy source. For example, when the battery is charged, it is a power load appliance and otherwise it becomes a energy source.

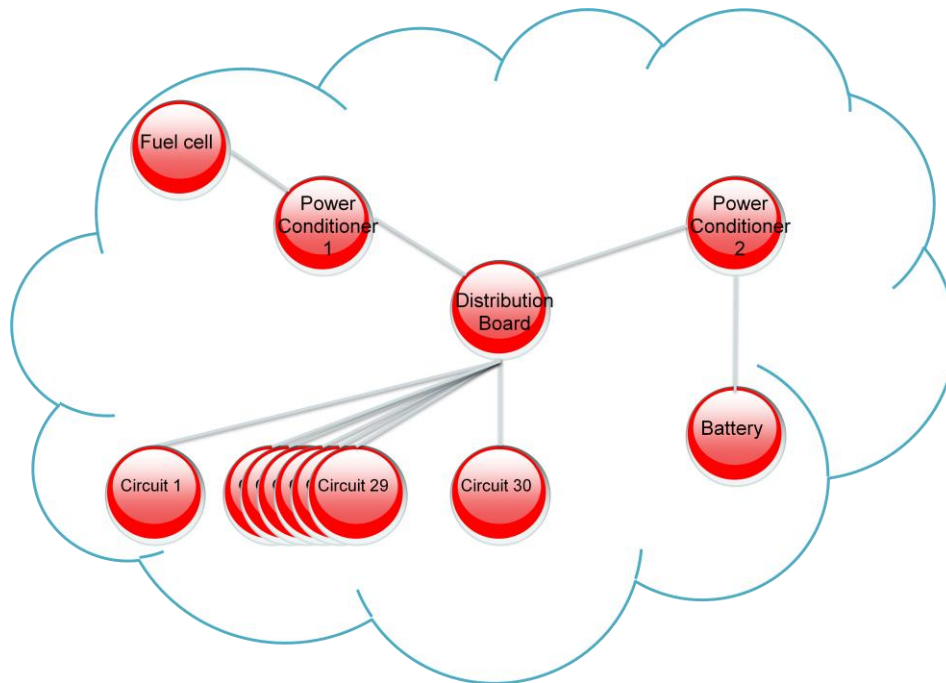

Figure 3.20: The electric energy simulation model

# Chapter 4

## Implementation

### 4.1 Implementation Model

The existing home network simulator consists of 5 components: house, environment, human, appliance and electric energy. In this research, we insert a thermal energy into this simulator. Therefore, we also implement it based on the existing implementation model of the simulator. Each component has its specific function. It is necessary to implement it in the different space. However, a component also needs some information of another component for implementing its simulating task. Sometimes, an element belongs to two or three components. Therefore, the implementation model relies on the network model that each component is a network. The network contains nodes and edges that connect nodes together. A node can be belonged to two networks. A network communicates with another through sending a message to the edge connects two elements of those networks.

**Network:** contains some information of nodes and edges and controls the communication traffic of nodes. Network is a simulation of a real network. For example, the electric energy simulator implement based on the electric energy network in home.

**Nodes:** contains some specific information of that node. A node expresses a function, a task or a device in the network. For example, in the electric energy network, node depicts power plug, circuit and distribution board. A node can belong to two networks such as a watt meter that belongs to both the appliance network and the electric energy network.

**Edges:** create a communication between two nodes. An edge contains information of left node and right node that it connects.

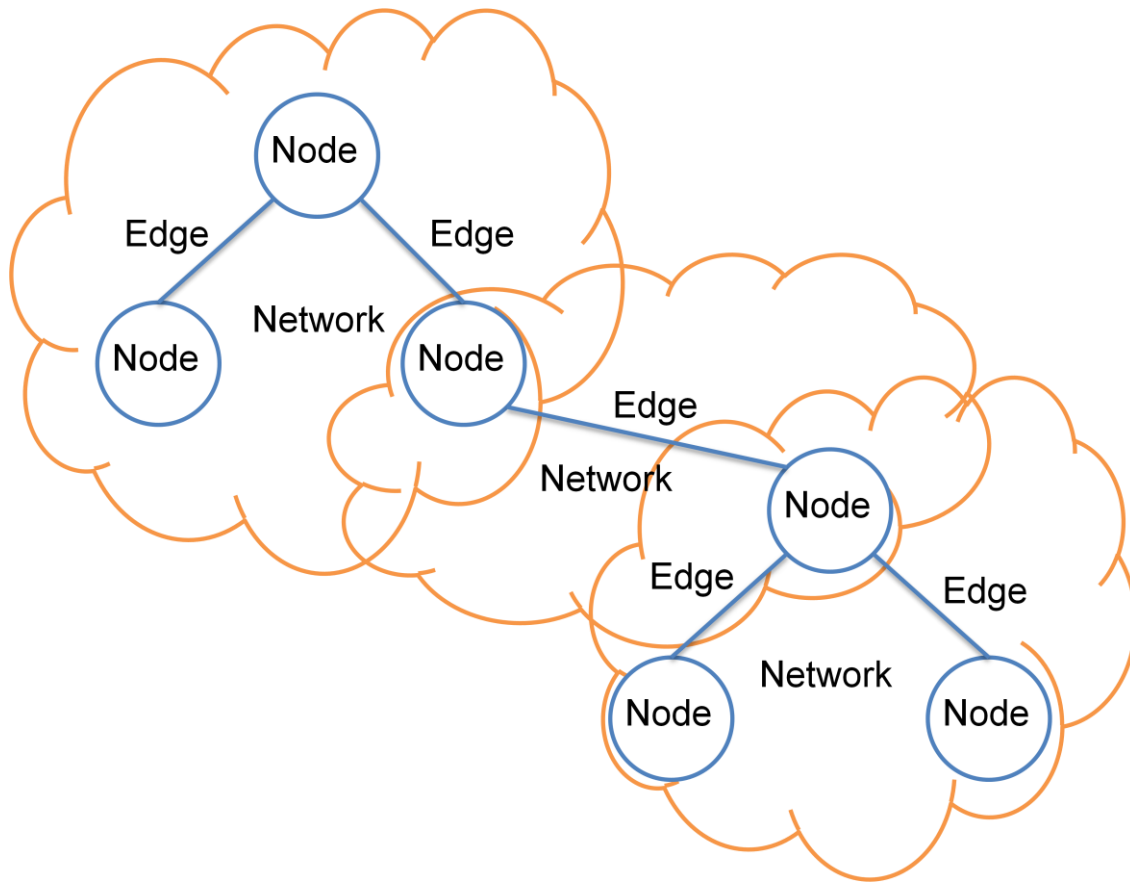

Figure 4.1: The implementation model

## 4.2 Thermal Energy Simulation Implementation

The thermal energy simulation also is implemented based on the network model that simulates the thermal energy network in home. In this section, we will discuss the structure of the implementation such as UML depicts relationship of classes, the properties of each class and configuration file. We define structure of thermal energy system in home by a configuration file. This is thermal configuration file that defines some properties of connection pipes, water pipes and their relationship. Each pipe contains some information like type, maximum flow rate and other.

```
[Thermal]
ConnectionPipe = ConnectionPipe1,ConnectionPipe2,ConnectionPipe3,ConnectionPipe4
WaterPipe = WaterPipe1,WaterPipe2,WaterPipe3,WaterPipe4,WaterPipe5,WaterPipe6
[[ConnectionPipe1]]
type = WaterPipe
index = 1
children = 2,3
maxA = 80.
direction = 1
locationA = Tank
```

locationB = ConnectionPipe2

Beside that, we define which appliances will be connected to a pipe through room configuration file. This file is describe the structure of house like wall, size of wall, direction of wall, which appliance positioned in a room and which circuit, water pipe is connected to that appliance.

```
[Kitchen]
width = 2.275
depth = 3.185
height = 2.400000
recommended_lux = 100.0
nextroom = EntranceHall,LivingRoom
walls = 4
    [[wall1]]
    room = Out
    myFace = B
    width = 3.185
    height = 2.4
    wallname = outerWall
    direction = W
    windows = 1
    [[appliance]]
    num = 10
        [[[appl8]]]
        name = refrigerator
        type = toshiba
        circuit = circuit19
        [[[appl9]]]
        name = valvecontroller
        type = TOSHIBA
            circuit = circuit19
            pipe = WaterPipe4
        [[[appl10]]]
        name = valvecontroller
        type = TOSHIBA
        circuit = circuit19
            pipe = WaterPipe5
```

We make a simulator that can be set up regarding the configuration file. Therefore, the simulator can be simulator any house you want. After designing the configuration file, we start to implement the thermal energy simulation, the energy system that supplies both heat and power. We implement the simulator regarding the structure of i-House as the figure below. Each circle expresses for a class. The orange circles are implemented by myself and the black circles are available in the existing home simulator.

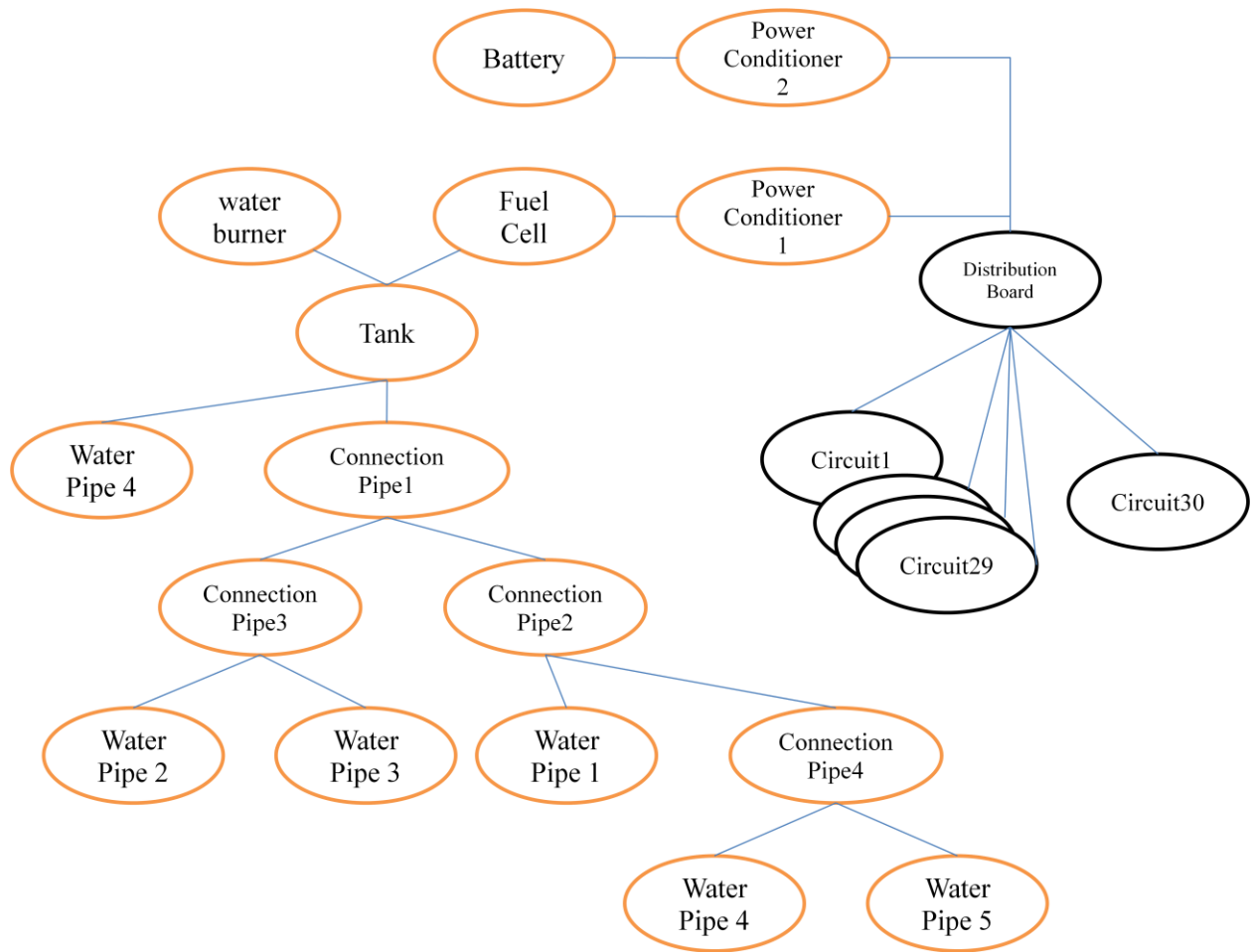

Figure 4.2: The implementation of thermal energy simulation and electric energy simulation



# Chapter 5

## Test cases and results

### 5.1 Experiment the accuracy of the simulator

#### 5.1.1 Scenario Explanation:

We evaluated the simulator by simulating a scenario and observe the results like the change of the water temperature in tank, power consumption, power supply of the energy system and other. Then, we can evaluate the accuracy of the simulator by observing the interaction between these results.

Before we make some specific scenarios, we need to set up some general configuration. House configuration: is set up based on the structure of the i-House that consists of entrance hall, toilet, lavatory, living room, kitchen, Japanese style room, bathroom and other.



Figure 5.1: The overview of i-House

- ❖ **Human configuration:** consists of two persons (father and mother) with the day time schedule like the table below:

Father schedule	Mother schedule
00:00 00:36 personalcare: bathing 00:36 00:41 personalcare: brush_tooth 00:41 07:58 sleep: sleep 07:58 08:28 meals: breakfast 08:28 08:33 personalcare: brush_tooth 08:33 08:43 personalcare: personal_care 08:43 09:30 commuting: commuting 09:30 12:30 work: work 12:30 13:00 meals: lunch 13:00 19:21 work: work 19:21 20:08 commuting: commuting 20:08 20:47 meals: dinner 20:47 23:03 hobby: hobby 23:03 23:38 personalcare: bathing 23:38 00:00 rest: rest	00:00 06:13 sleep: sleep 06:13 07:13 housework: cooking 07:13 07:18 personalcare: brush_tooth 07:18 07:28 personalcare: personal_care 07:28 07:58 meals: breakfast 07:58 08:28 housework: washing 08:28 09:28 housework: cleaning 09:28 11:20 tv: tv 11:20 12:00 housework: cooking 12:00 12:30 meals: lunch 12:30 12:35 personalcare: brush_tooth 12:35 12:45 personalcare: personal_care 12:45 14:00 tv: tv 14:00 16:05 social: social 16:05 16:48 tv: tv 16:48 17:30 shopping: shopping 17:30 18:30 housework: cooking 18:30 19:05 personalcare: bathing 19:05 19:43 meals: dinner 19:43 20:03 housework: houseworks 20:03 21:58 tv: tv 21:58 22:03 personalcare: brush_tooth 22:03 23:30 tv: tv 23:30 00:00 sleep: sleep

- ❖ **Energy system configuration:**

- Fuel cell system (FCP-075CPG2 type)
- Tank size: 200 liter
- Maximum water temperature in tank: 65 Celsius
- Maximum supplied water temperature: 60 Celsius
- Power rate: 750 watt
- Thermal rate: 1070 watt
- Gas consumption: 2100 watt
- Electric performance: 35%
- Thermal performance: 50%
- Water Burner
- Burner warming water rate: 12kwatt
- Maximum burner rate: 50kwatt
- Minimum burner rate: 9kwatt

- Performance: 80%

❖ **Battery**

- Battery volume: 47.5Ah
- Voltage output: 178V
- Charging power amount: 1kw
- Power conditioner
- Maximum power output: 4.5kwatt
- Output voltage: 100V
- DC-AC Performance: 93%
- AC-DC Performance: 90%

### 5.1.2 Case1: Evaluate the accuracy of the thermal energy simulation

❖ **Conditions:** we make a scenario that consists of some conditions.

- FC turns on when: water temperature in tank < 45 °C
- FC turns off when: water temperature in tank > 55 °C & the hot water of the tank is full.
- FC generating power > power consumption => the surplus power will be used to charge battery.
- FC generating power < power consumption => Using power from power company.
- Desired temperature of hot water supply: 38 Celsius
- Temperature condition to turn on the warming function of fuel cell system: 35 Celsius

❖ **Result:**

The figure depicts water consumption and total water consumption according to time. In order to have the real result of water consumption, we have applied a realistic domestic hot water profiles for this simulation. Finally, we have the result of total water consumption is about 500 liters a day. Look at the figure we see that the utility time of hot water is comfortable with human schedule. Regarding to the father and mother’s schedules, they go bath at 19 o’clock and 23 o’ clock. Therefore, the water consumption of water pipe 6 increases at this time.

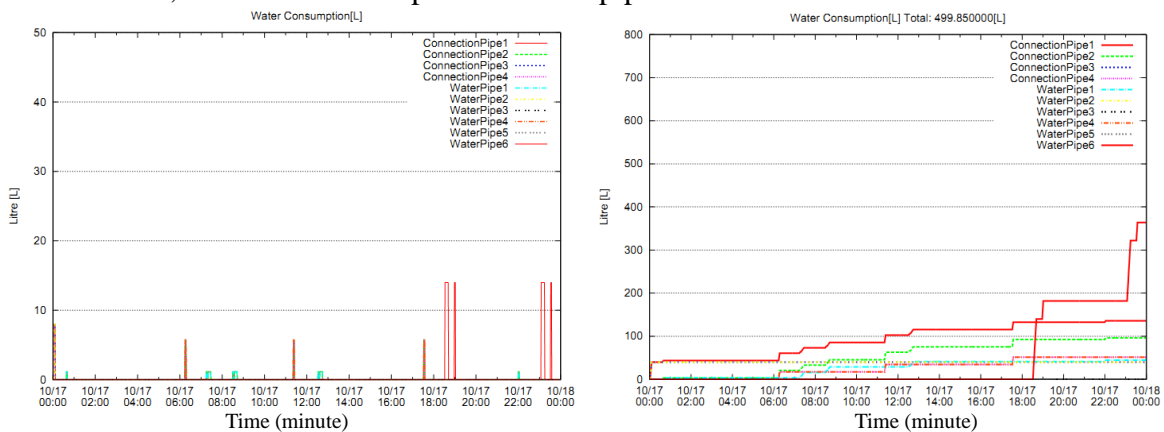

Figure 5.2: The water consumption & total water consumption result

Observing the water consumption result and the hot water temperature in the figure below, we can verify the accuracy of the thermal energy simulation. The hot water temperature increases and decreases according to time. However, the highest temperature can not over 55 °C, because of the initial scenario setting.

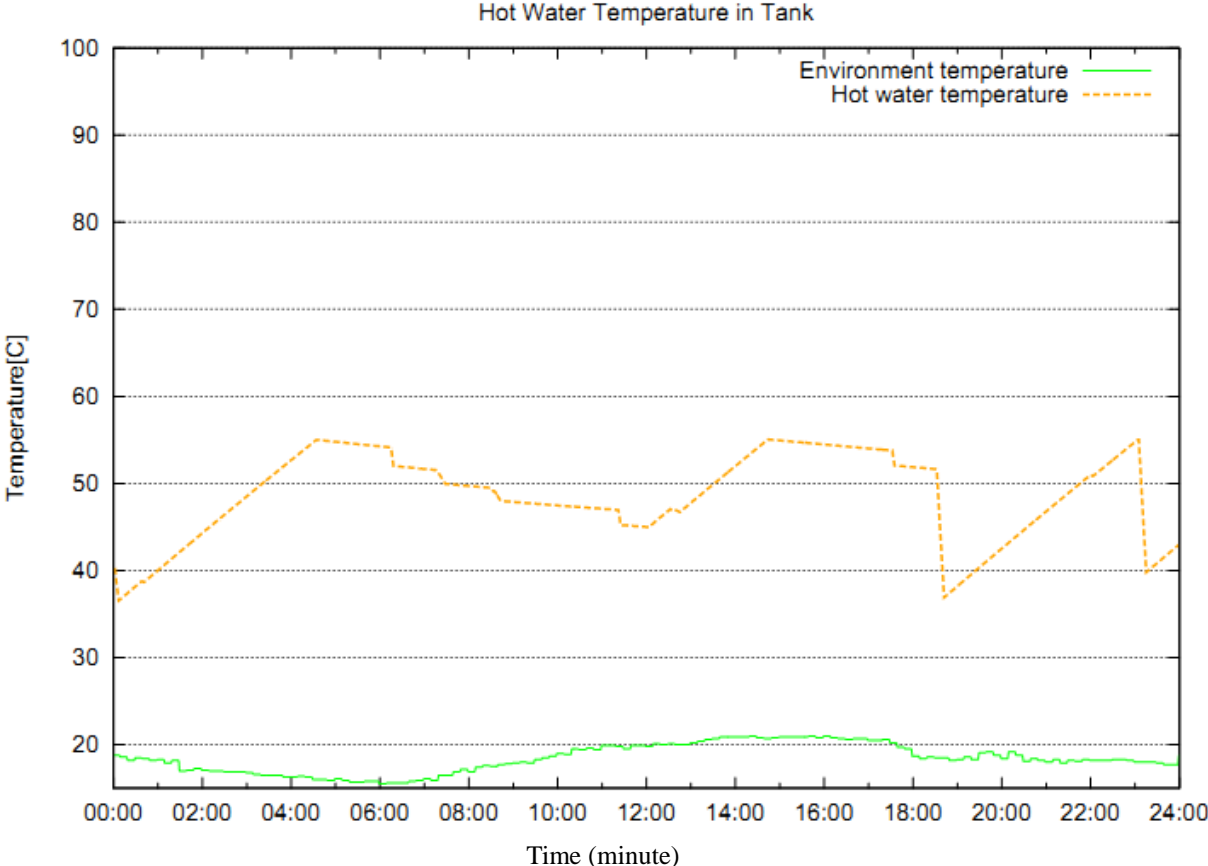

Figure 5.3: Hot water temperature in tank

The figure depicts the heat supplied by auxiliary heat device when the supplied heat of hot water tank is not enough. We divide two type of supplied heat: hot water supply and bathtub water supply. Bathtub water supply means that when the water temperature in tank decreases to a temperature limit, the auxiliary heat device will supply an additive heat for warming the water in the bathtub.

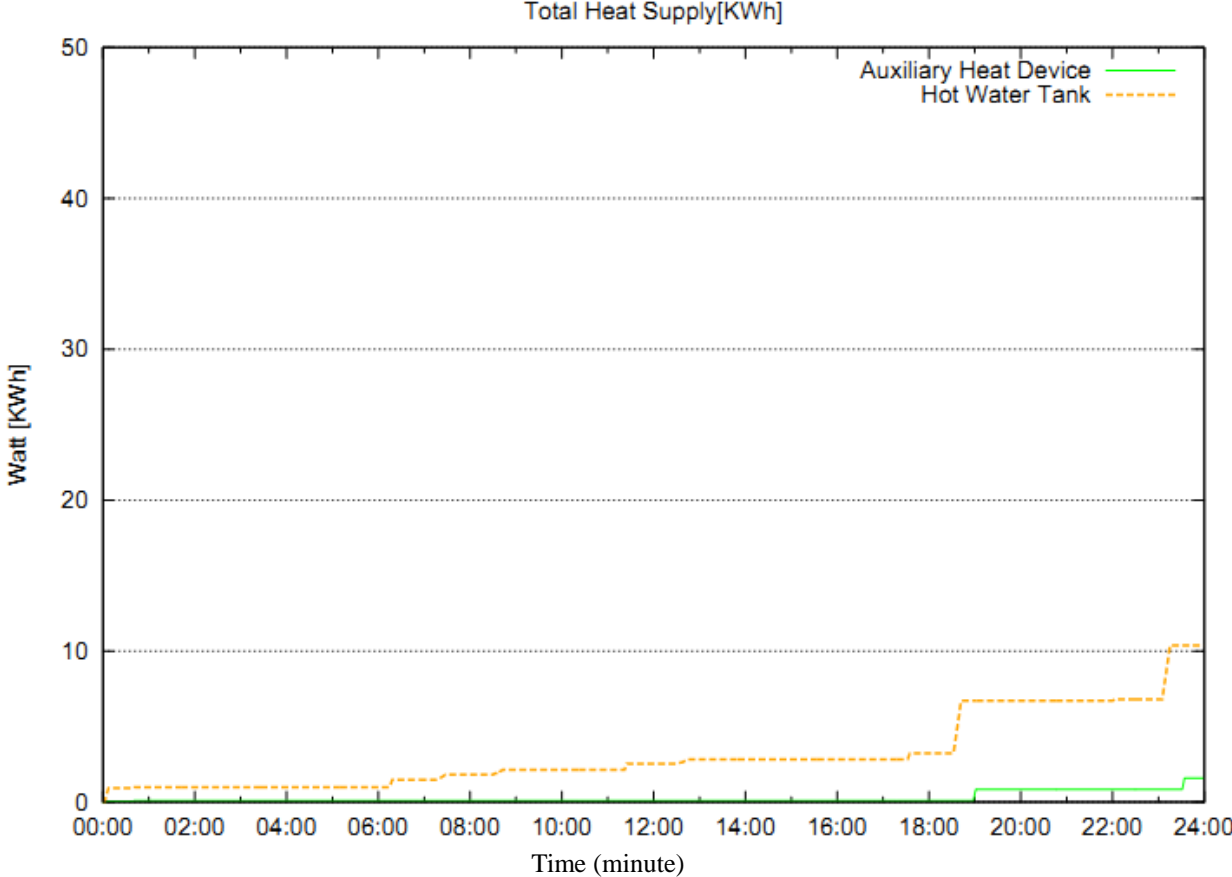

Figure 5.4: The total heat supply by auxiliary heat device

### 5.1.3 Case2: Evaluate the accuracy of the energy generation system (Battery, fuel cell)

Using the scenario configuration in case 1, we will evaluate the accuracy of the energy generation system based on the interaction of the results. This figure depicts the electric energy consumption of each circuit and distribution board. In distribution board line, we see that the top peak of power consumption is about 8 o'clock because the power needs increase at this time.

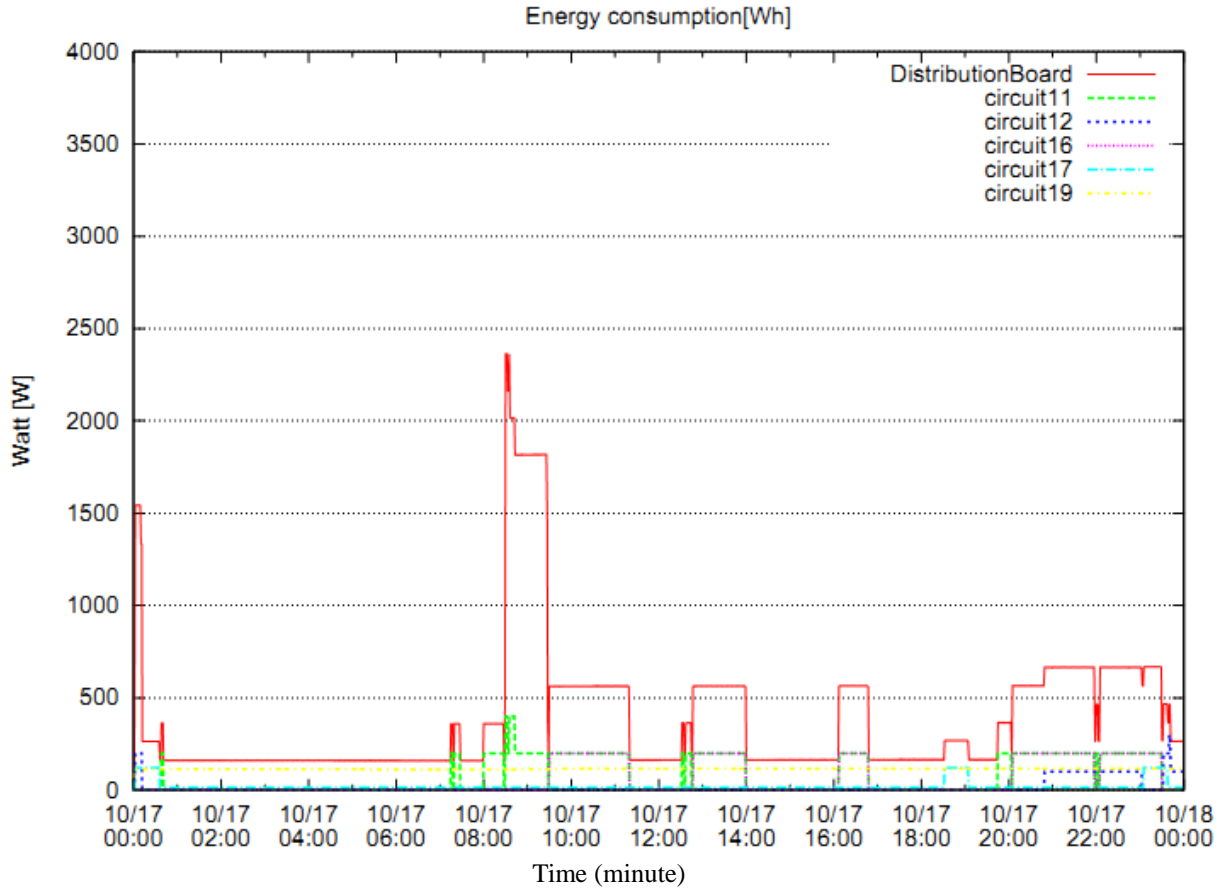

Figure 5.5: The electric energy consumption

Observing the electric energy consumption result and power supply result in the figure below, we can verify the accuracy of the electric energy simulation. In the above picture, the top peak of power consumption is about at 8 o'clock. In this figure, we buy the power from company most at this time for supplying power needs. The power generated by fuel cell system is about 750 watt and vary on the time that is set up in this scenarios.

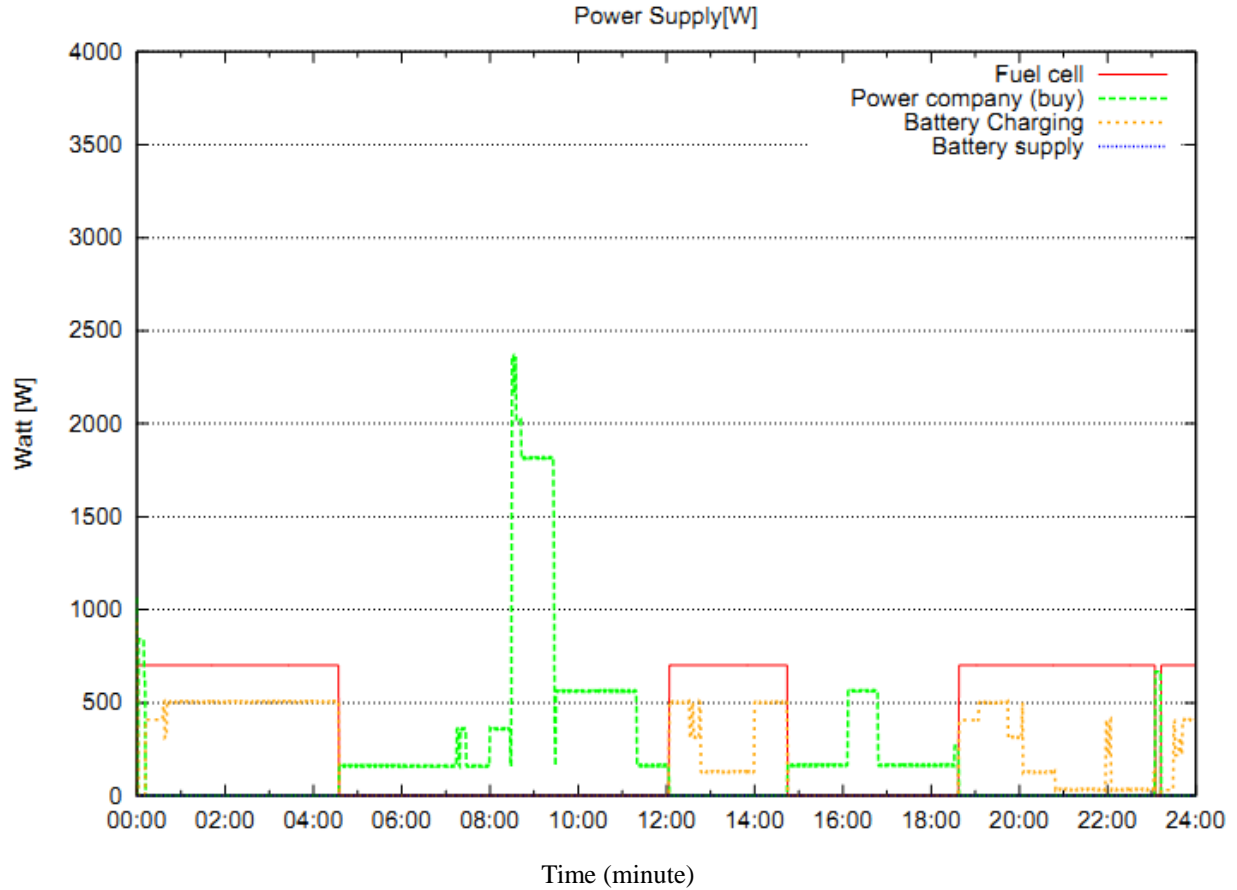

Figure 5.6: The electric energy supply

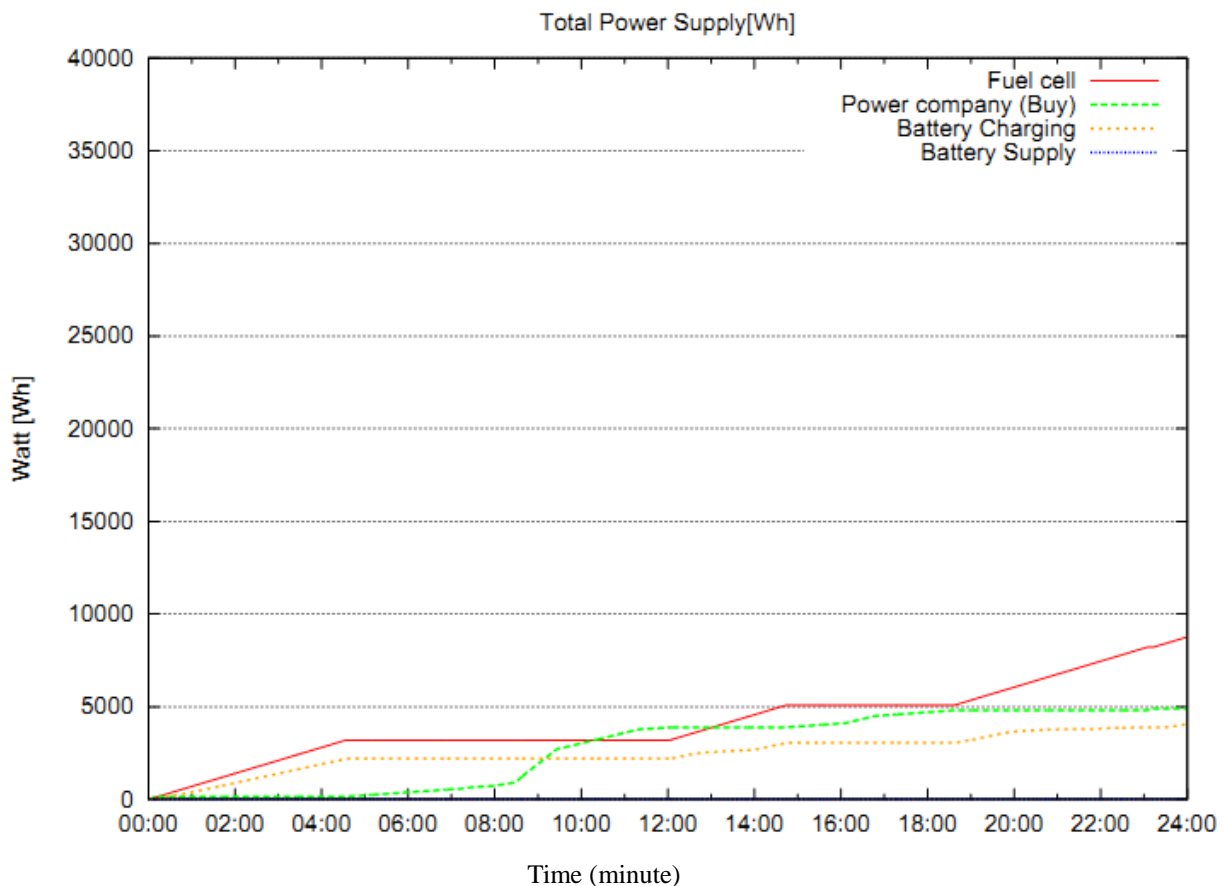

Figure 5.7: The total electric energy supply

### 5.1.4 Case 3: Multi homes simulation:

We set up two houses with the same house structure and human number. However, the schedule of human is different from others. These two houses shared a next generation energy system together. We set up some condition as well as priority order to receive energy supply.

#### ❖ Conditions:

- The power generated by FC will be supplied for:
  - The power consumption of house 1
  - The power consumption of house 2
- - Charging battery.
- FC generating power < power consumption => Using power from power company.
- FC turns on when: water temperature in tank < 60oC
- FC turns off when: water temperature in tank > 65oC & the hot water of the tank is full.
- Desired temperature of hot water supply: 38 Celsius
- Temperature condition to turn on the warming function of fuel cell system: 35 Celsius



❖ **Results:**

Running the simulator based on this configuration, we have the results as below. The figures depict water consumption and total water consumption according to time. In order to have the real result of water consumption, we have applied a realistic domestic hot water profiles for this simulation. Finally, we have the result of total water consumption is about 200 liters a day. Look at the figure we see that the utility time of hot water is comfortable with human schedule.

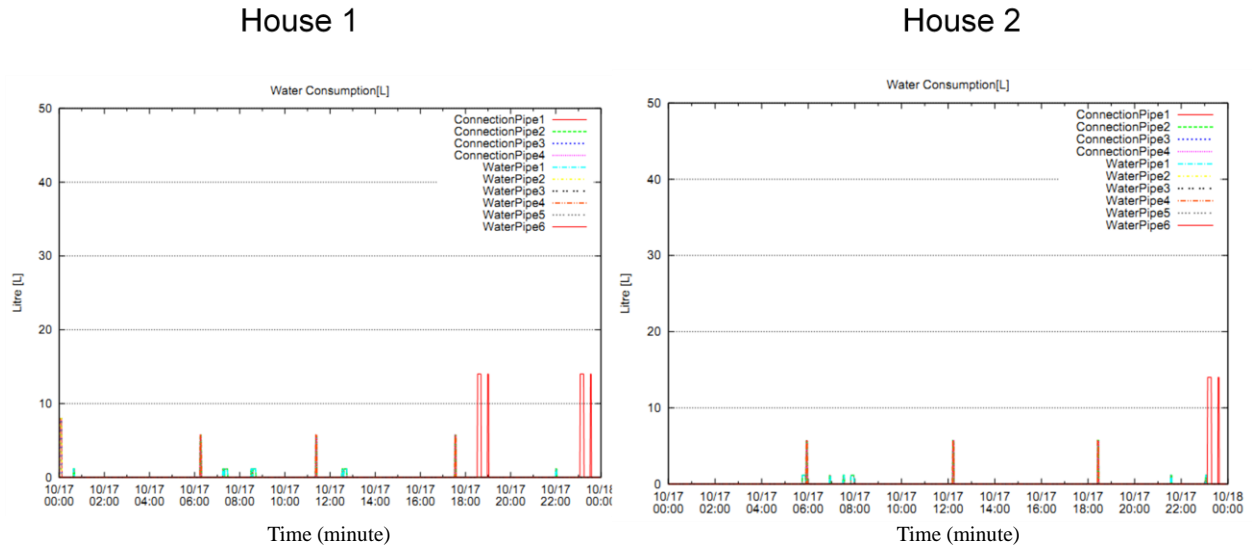

Figure 5.8: The water consumption of house 1 and house 2

Observing the electric energy consumption result and power supply result in the figure below, we can verify the accuracy of the electric energy simulation at house 1 and house 2. In the energy consumption picture, the top peak of power consumption is about at 8 o'clock. In power supply figure, we buy the power from company most at this time for supplying power needs. The power generated by fuel cell system is about 750 watt and vary on the time that is set up in this scenarios. This power will be shared by these two houses.

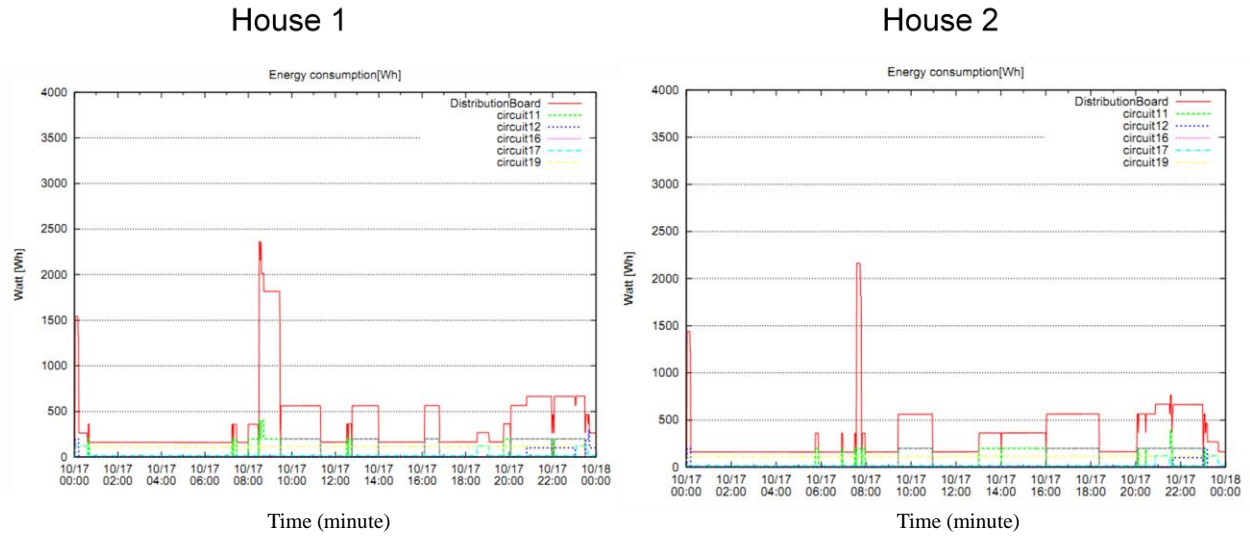

Figure 5.9: The electric energy consumption of house 1 and house 2

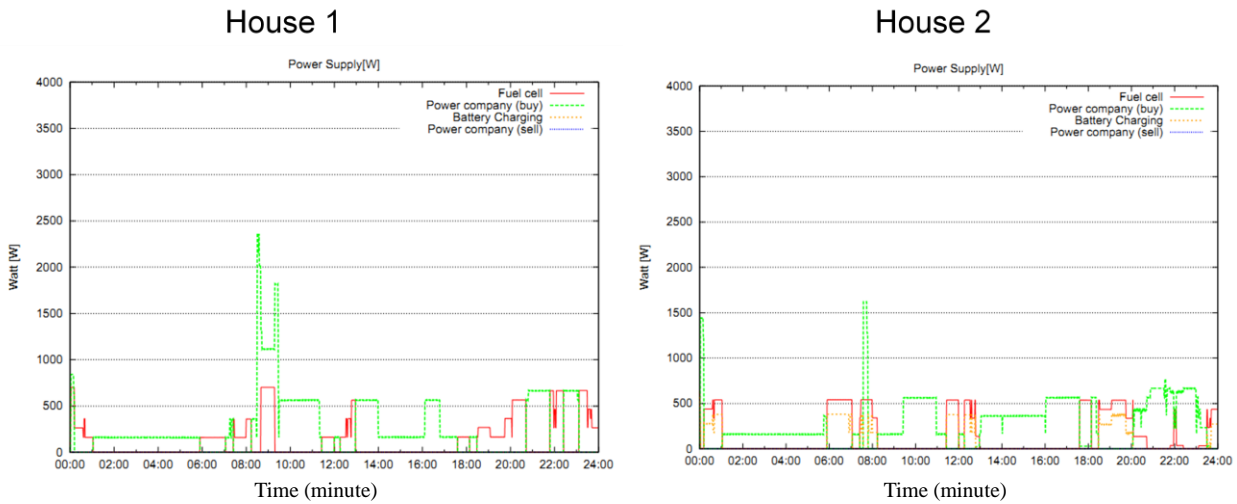

Figure 5.10: The electric power supply for house 1 and house 2

## 5.2 Energy Performance Evaluation

### 5.2.1 Improving energy performance

In order to find out the way to improve energy performance, we make some statistic and calculation concerning about electric money, gas money and energy system efficiency.

- ❖ Electric money: is calculated based on the utility time.
  - In day time (start from 8 o'clock to 22 o'clock): 23.16 yen (1kWh)
  - In night time (except day time): 7.43 (1kWh)
- ❖ Gas money: with 1 m<sup>3</sup> gas, we lose 123 yen and the LHV of this gas type is about 11.28Kwh/m<sup>3</sup>
- ❖ In case 1: using fuel cell system:
  - FC lose 2.1kw gas to create: 0.75kw power (power efficiency: 35%) and 1.07kw heat (heat efficiency: 50%)
  - With 2.1kw gas, we need:  
 $2.1k/11.28kwh*123yen = 0.38yen$
  - Efficiency of power conditioner is 93%:

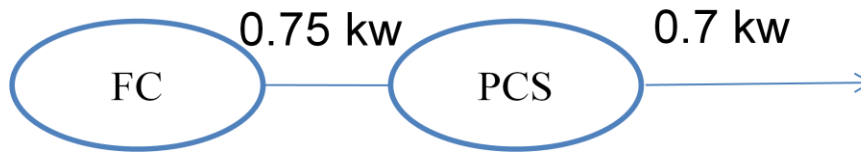

- Therefore, with 0.38 yen we will receive 0.7kw (power) and 1.07kw (heat).
- ❖ In case 2: not using fuel cell system:
  - Receiving power from the power company:
    - Daytime: 0.7kw power = 0.27yen (23.16 yen/1kWh)
    - Nighttime: 0.7kw power = 0.087yen (7.43 yen/1kWh)
  - Heating water use auxiliary heat device (Efficiency 80%)
    - $1.07kw \text{ (heat)} / 0.8 = 1.3375kw / 11.28kwh * 123 \text{ yen} = 0.24yen$
  - We can calculation total money regarding the utility time like below:
    - Daytime: 0.7kw (power) + 1.07kw (heat) = 0.51 yen
    - Nighttime: 0.7kw (power) + 1.07kw (heat) = 0.327 yen

Based on the calculation of case 1 and case 2, we take out a conclusion to improve energy efficiency as below:

- ❖ At night time: 0.38yen (use FC) > 0.327 yen (not use FC) => Using FC only at daytime
- ❖ At daytime: 0.38yen (use FC) < 0.51 yen (not use FC) => Using FC when domestic

needs consists of both power and heat. Namely, FC can use when the water temperature of the tank < 65 Celsius and power needs (or battery is not full)

The money consumption of battery: the efficiency of battery is different depending on converting direction. The efficiency of AC-DC is 93% and DC-AC is 90%.



Saving 1kwh power into battery at night time and using that power at daytime, we need

$$1\text{kwh (power)} * 0.93 * 0.9 = 0.837\text{kwh} * 7.43 \text{ yen} = 6.22 \text{ yen}$$

Beside that, in order to receive 0.837kwh at daytime from the power company, we will lose  
 $0.837\text{kwh} * 23.16\text{yen} = 19.38 \text{ yen}$

Therefore, we should save power into battery at nighttime and use that power at daytime.

When we combine fuel cell and battery together, we take out some conclusion like below:

- ❖ At day time if we run FC and
  - FC generation power > power needs, the surplus power should be save into battery.
  - FC generation power < power needs, the lack power will be supplied by battery.
- ❖ At day time if we do not run FC, we can use battery for supplying electricity.

### Scenario and result:

Based on the calculation and conclusion concerning about the improvement of energy efficiency. We make a scenario configuration and evaluate the results.

- ❖ Timing:
  - Using FC at day time (8h - 22h)
  - Charging battery at night(from 0h)
- ❖ Conditions:
  - FC turn on when: water temperature in tank < 45 °C
  - FC turn off when: water temperature in tank > 55 °C & tank volume = full
  - FC generating power > power consumption => the surplus power will be used to charge battery.
  - Using battery for supplying electricity when battery is full.
- ❖ Initial set up
  - Initial charged power in battery: 0 Ah
  - Initial tank temperature: 40 Celsius
  - Running the simulator we have the results:

We will evaluate the energy performance based on three elements: money, storing heat amount in tank and storing power amount in battery. Then, these three elements will be converted to money for evaluating.

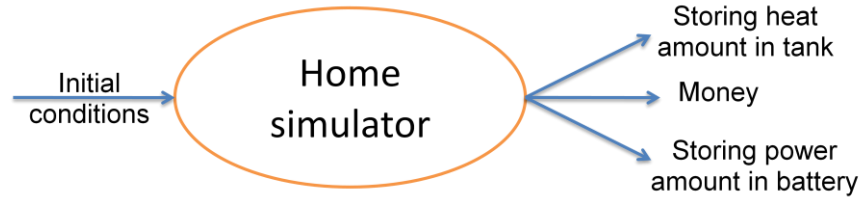

In order to evaluate the energy efficiency, we make two other scenarios.

- ❖ Scenario 2: Using FC all time:
  - Turn on when water temperature in tank < 45°C
  - Turn off when: water temperature in tank > 55°C
  - The surplus power will be used to charge battery.
- ❖ Scenario 3: Do not use FC and Battery.

Running these three scenarios, we make a comparison of these scenarios based on three elements: Money, Storing heat amount in tank, Storing power amount in battery. We have the results:

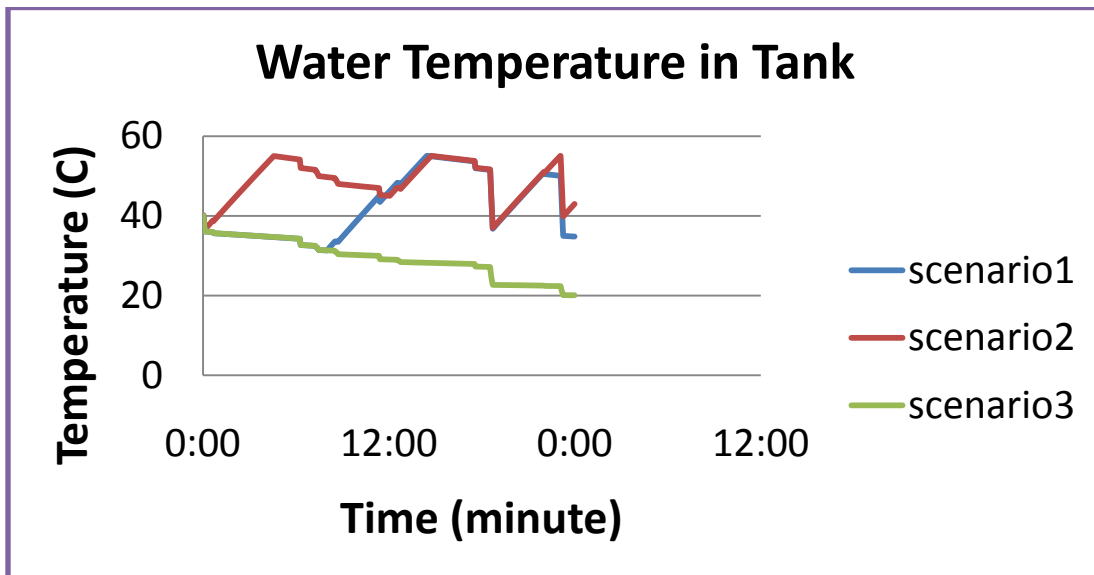

Figure 5.11: The water temperature in tank of each scenario

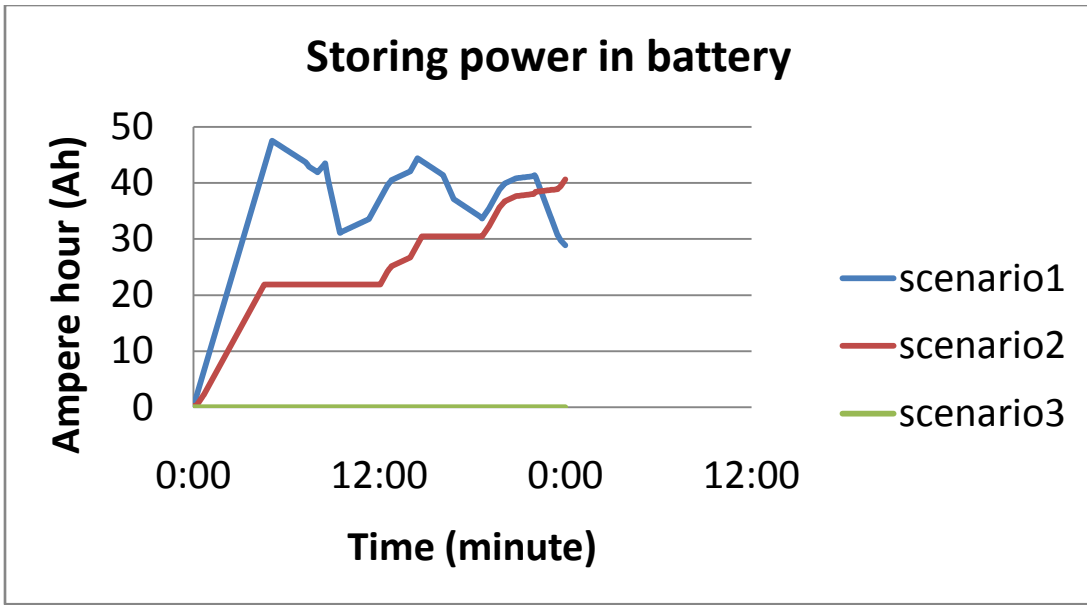

Figure 5.12: The storing power amount in battery corresponding to each scenario

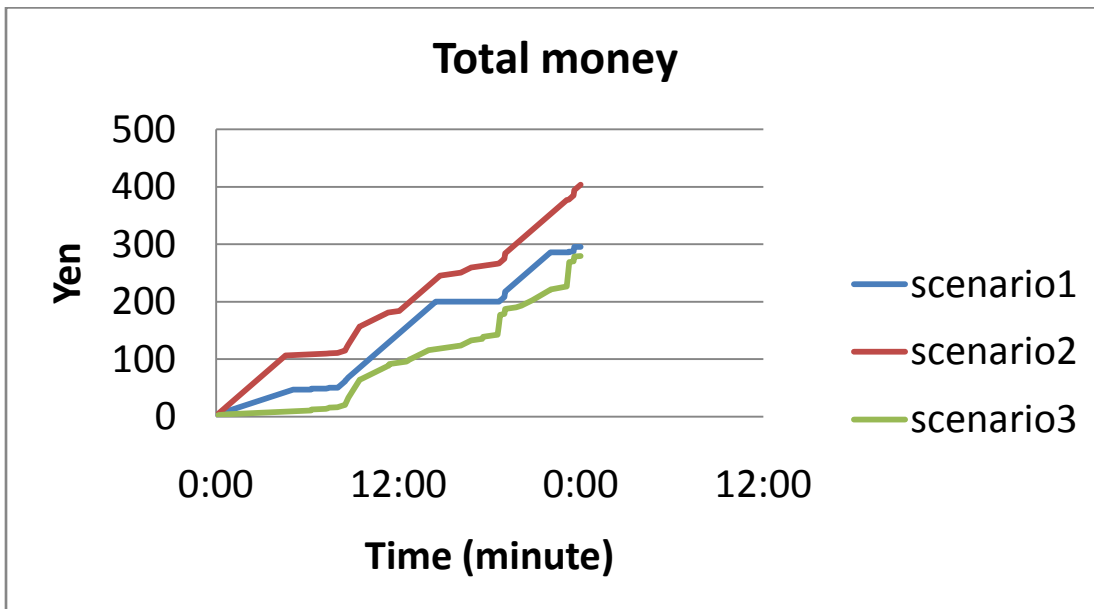

Figure 5.13: The total spending money corresponding to each scenario

Based on these result we make a statistic bar graph to depict evaluation between these scenarios.

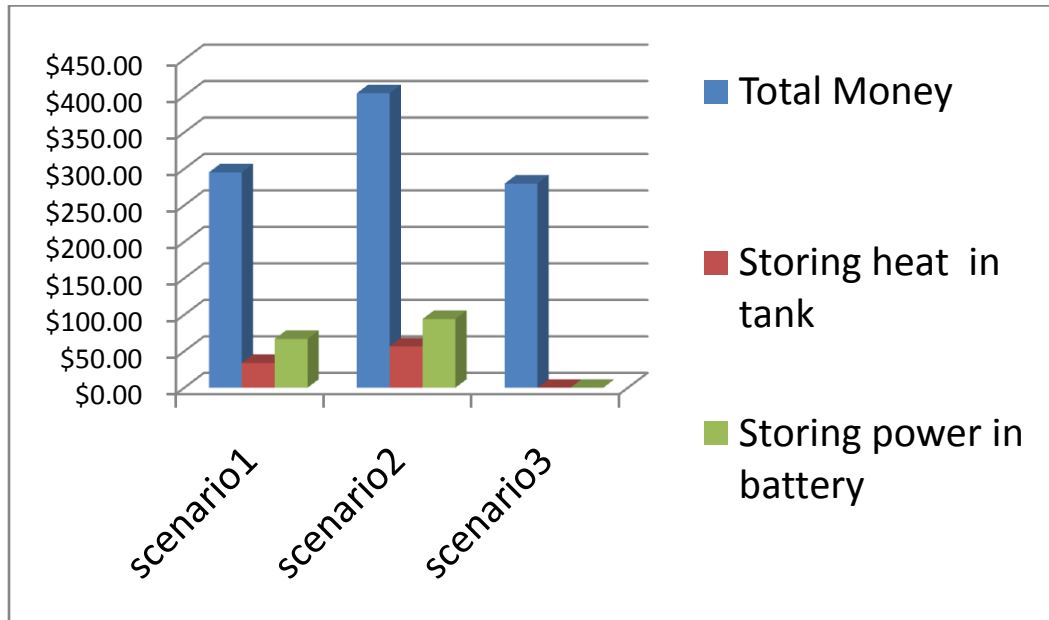

Figure 5.14: The evaluation of energy efficiency based three elements

However, we can not evaluation the performance based on three elements. Therefore, we convert these three elements into a element that is money. We can calculate the thermal needs to heat water to depicted temperature, then we can calculate the money required. After converting to money, we make subtraction operation. We have a final evaluation result like the figure below.

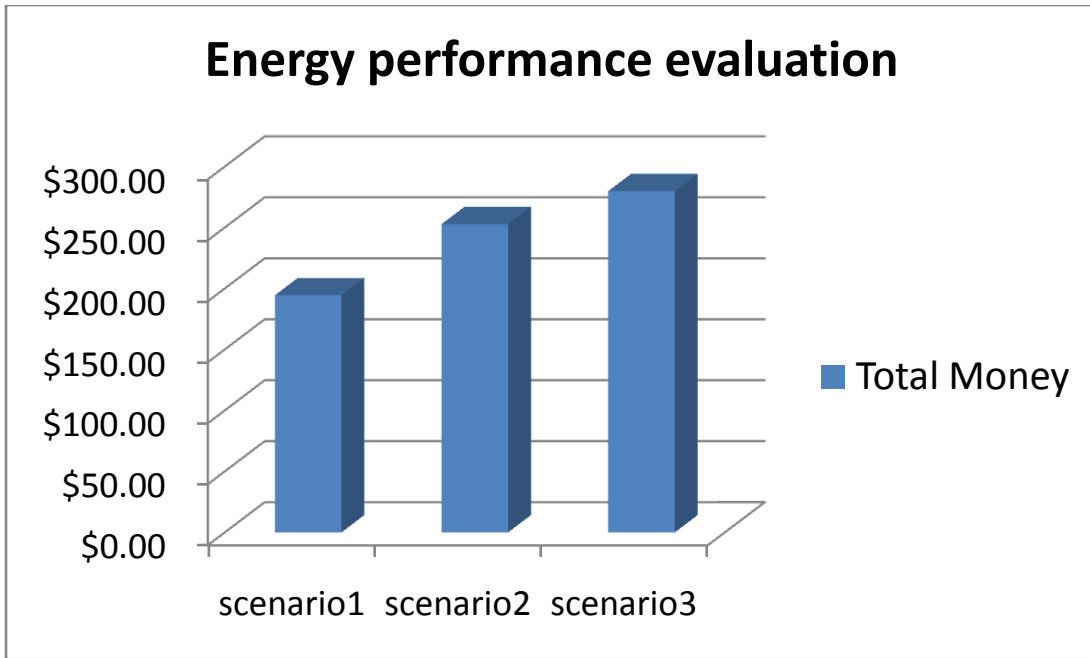

Figure 5.15: The evaluation of energy efficiency based total spending money

Observing the figure, we see that we can save the money most in the scenario1 that applied an energy improvement method for it. In the scenario 3, we lose more money because we didn't use battery and fuel cell for supplying energy.



# Chapter 6

## Conclusions

In this research we have proposed a thermal energy simulator that can verify and evaluate home network service and system. The simulator also was integrated in the existing home environment simulator in order to become a homogeneous system. This system consists of 6 components: house simulator, human simulator, environment simulator, home appliance simulator, electric energy simulator and thermal energy simulator. Between components exists a relationship that helps them to communicate to another. Based on this system, we can verify and evaluate many various fields concerning about home network such as energy consumption & supply, energy efficient thermal comfort, etc. Beside that, we have also implemented a next generation energy system that is shared to supply both electricity and heat in home. Combination of a next generation energy system, thermal energy simulation and electric energy simulation can be used to evaluate energy efficiency based on the way of using energy system.

The accuracy of the simulator was verified by some specific scenarios and the accurate results of those scenarios. The simulator can also be used to simulate multi-homes or multi-homes shared an energy system together. We also evaluated energy efficiency by improving the utility of fuel cell system and battery according to time, gas money and electric money efficiently.

# Appendix A

## Configuration file

In this research we implemented the home simulator that was configured by some configuration files. In this section, we will explain the structure of configuration file and how to set up them regarding the structure of the house. There are a lot of configurations for house, human, appliance, environment and other. You can get this information by [1]. We will explain some additive configuration that expresses the thermal energy network and energy system in home.

### A-1 Configuration of thermal energy network

[Thermal]

ConnectionPipe = ConnectionPipe1, ConnectionPipe2, ConnectionPipe3, ConnectionPipe4

WaterPipe = WaterPipe1, WaterPipe2, WaterPipe3, WaterPipe4, WaterPipe5, WaterPipe6

[[ConnectionPipe1]]

type = WaterPipe

index = 1

children = 2,3

maxA = 80.

direction = 1

locationA = Tank

locationB = ConnectionPipe2

...

[[WaterPipe1]]

type = WaterPipe

index = 1

children = 0,

maxA = 15.

direction = 1

locationA = ConnectionPipe2

locationB = Lavatory

- Type:  
Defines the type of pipe
- Index:  
Give pipe an index number that is used to find out the children-father relationship between pipes.
- Children:  
Defines its the children's index number

- maxA:  
Maximum water flow rate
- locationA:  
Define the start head of a double-headed pipe
- locationB:  
Define the end head of a double-headed pipe

## A-2 Configuration of energy system

```

[[FuelCell]]
  class = FuelCell
  [[[type]]]
    types = FCP-075CPG2
    prop= generatingpowerrate, generatingThermalRate, warmingRate,
    burnerMaxRate, burnerMinRate, tanksize,tankarea,
    gasConsumption, gasType,money, burnerEfficiency,
    powerEfficiency, thermalEfficiency.
  [[[[FCP-075CPG2]]]]
    generatingpowerrate = 750.
    generatingThermalRate = 1070.
    warmingRate = 12000.
    burnerMaxRate = 50000.
    burnerMinRate = 9000.
    tanksize = 200.
    tankarea = 2.1
    gasConsumption = 2100
    gasType = 11.28
    money = 123
    burnerEfficiency = 0.8
    powerEfficiency = 0.35
    thermalEfficiency = 0.5
  [[env]]
    edges = recv1,
  [[[[recv1]]]]
    edge = ApplianceEdge
    sender = environment
    sendFunc = sendTemperature
    recvFunc = recvTemperature
    level = 1

```

- **Class:**  
Define class of energy generation device. Its name is similar to the class name of that energy generation device in source code.
- **Type:**  
Define the type of the energy generation device
- **Prop:**  
Define the property of energy generation device
- **Edges:**  
Define the edges will connect this energy device to other device
- **Env:**  
Define the edge that will connect this energy device to environment simulator.
- **Edge:**  
Define the type of the edge. Its name is similar to the class name of that edge in source code.
- **Sender:**  
Define who will become a sender in this edge.
- **sendFunc:**  
Define the send function that will be used to send data.
- **recvFunc:**  
Define the receive function that will be used to receive data.
- **Level:**
- Define the timing when we use a edge for communicate.
- **Generatingpowerrate:**  
The property that expresses generated power amount by the fuel cell.
- **generatingThermalRate**  
The property that expresses generated heat amount by the fuel cell.
- **warmingRate**  
The property of the auxiliary heat device that expresses maximum heat will be used to warm the water
- **burnerMaxRate**  
The property of auxiliary heat device that expresses maximum heat will be used to heat the water.

- burnerMinRate  
The property of auxiliary heat device that expresses minimum heat will be used to heat the water.
- tanksize  
The volume of the tank
- tankarea  
The surrounding area of the tank
- gasConsumption  
The gas consumption is used to generate power and heat.
- gasType  
Gas type is used in the fuel cell system.
- money  
The money of 1kwh gas
- burnerEfficiency  
The efficiency of the auxiliary heat device
- powerEfficiency  
The efficiency of fuel cell for generating power
- thermalEfficiency  
The efficiency of fuel cell for generating heat

[[Battery1]]

class = Battery

edge = dis,

[[[type]]]

types = FCP-075CPG2

prop = powervolumn, inputV, outputV, maxoutput,  
supplyEfficiency, chargeEfficiency

[[[[[FCP-075CPG2]]]]]

powervolumn = 47.5

inputV = 100.

outputV = 100.

maxoutput = 4.5

supplyEfficiency = 0.9

chargeEfficiency = 0.935

- powervolumn:  
Define the size of the battery

- inputV:  
Define the input voltage of the battery
- outputV:  
Define the output voltage of the battery
- Maxoutput  
Define that maximum of electric amount that will be supplied.
- supplyEfficiency:  
Define the efficiency of the battery when it supplies electricity.
- chargeEfficiency:  
Define the efficiency of the battery when it is charged.

```

[[PowerConditioner1]]
  class = PowerConditioner
  edge = dis,FC
  [[type]]
    types = PV-PS18GA
    prop = parent,children,powerefficiency,maxoutput
  [[[PV-PS18GA]]]
    parent = 100.
    children = 100.
    powerefficiency = 0.935
    maxoutput = 4.5

```

- powerefficiency:  
Define the efficiency of the power conditioner
- Maxoutput:  
Define the maximum power amount that will be supplied
- Parent:  
The voltage of the parent node
- Children:  
The voltage of the child node

# Bibliography

- [1] ホームネットワークサービスおよびそのシステムの実証、岡田 崇(September, 2011)  
スマートハウス実証プロジェクト報告書
- [2] IEEE STANDARDS ASSOCIATION IEEE 802.3 ETHERNET WORKING GROUP,  
(online), available from (<http://www.ieee802.org/3/>)
- [3] Fuel cell modeling for building cogeneration applications, Alex Ferguson & Ismet Ugursal  
(april 2004)
- [4] A comparative assessment of fuel cell cogeneration heat recovery models, Alex Ferguson, Ian  
Beausoleil-Morrison, V.Ismet Ugursal (August, 2003)
- [5] Thermal Modeling and Control of Domestic Hot Water Tank, Vijay Dwivedi (September  
2009)
- [6] Realistic Domestic Hot-Water Profiles in Different Time Scales, Ulrike Jordan, Klaus Vajen  
(may 2001)
- [7] ECHONET, "ECHONET CONSORTIUM", (online), available from (<http://www.echonet.gr.jp/>)
- [8] UPnP, "UPnP Forum", (online), available from (<http://www.upnp.org/>)
- [9] A.H.Maslow, "A Theory of Human Motivation", Psychological Review, vol.50,  
pp.370{396, (1943).