

Title	Network Coding-aware MAC for Throughput Optimization in Wireless Multihop Networks
Author(s)	Lu, Pixian; Wang, Xin; Tan, Yasuo; Lim, Azman Osman
Citation	IPSJ SIG Technical Report on Mobile Computing and Ubiquitous Communications, 2012-MBL-63(14): 1-8
Issue Date	2012-08-23
Type	Journal Article
Text version	publisher
URL	http://hdl.handle.net/10119/10911
Rights	<p>社団法人 情報処理学会, Lu Pixian, Wang Xin, Tan Yasuo, and Lim Azman Osman, IPSJ SIG Technical Report on Mobile Computing and Ubiquitous Communications, 2012-MBL-63(14), 2012, 1-8. ここに掲載した著作物の利用に関する注意: 本著作物の著作権は(社)情報処理学会に帰属します。本著作物は著作権者である情報処理学会の許可のもとに掲載するものです。ご利用に当たっては「著作権法」ならびに「情報処理学会倫理綱領」に従うことをお願いいたします。 Notice for the use of this material: The copyright of this material is retained by the Information Processing Society of Japan (IPSJ). This material is published on this web site with the agreement of the author (s) and the IPSJ. Please be complied with Copyright Law of Japan and the Code of Ethics of the IPSJ if any users wish to reproduce, make derivative work, distribute or make available to the public any part or whole thereof. All Rights Reserved, Copyright (C) Information Processing Society of Japan.</p>
Description	

無線マルチホップネットワークにおけるスループットの最適化のためのネットワークコーディング対応MAC

陸 丕顕¹ 王 新² 丹 康雄¹ リム アズマン オスマン¹

概要: 無線マルチホップネットワークでは、端末間のホップ数の増加に伴い、スループットが著しく低下する。無線リンクの不安定さも影響するため、高スループットの実現は、挑戦的な課題となっている。本稿では、MAC層での中継手段を通じたデータ転送においてネットワークコーディング技術を使用する2ホップ経路選択プロトコル(CA-2PSP)を提案する。シミュレーション結果により、提案方式が従来のCSMA/CAに比してスループットを大幅に向上させることを明らかにした。

Network Coding-aware MAC for Throughput Optimization in Wireless Multihop Networks

LU PIXIAN¹ WANG XIN² TAN YASUO¹ LIM AZMAN OSMAN¹

Abstract: In wireless multihop networks, end-to-end throughput dramatically drops as the number of hops increases. Providing high throughput in these networks is challenging issue due to the unreliable wireless links. In this paper, we propose a coding-aware 2-hop path selection protocol (CA-2PSP), which uses a network coding technique on the data transmission through the MAC layer relaying strategy. Simulation results reveal that our proposed CA-2PSP significantly improves the throughput of conventional CSMA/CA.

1. Introduction

In recent years, much interest has been involved in the design of wireless multihop networks (WMN) for local communication such as civilian environment applications (*e.g.*, file sharing in a meeting room), disaster environment applications (*e.g.*, building a temporary communicate network for rescue activities). In practical, wireless multihop networks have been severely suffered the throughput degradation as the number of hops for data transmission increases. However, providing high throughput in wire-

less multihop networks is challenging issue due to the unreliable wireless links and the dynamic topology changes. Therefore, the way how to increase the throughput of the network is the important consideration while designing or deploying WMN.

Meanwhile, network coding [7], a new packet forwarding paradigm proposed by R. Ahlswede et al. recently which provide an elegant solution that could improve the throughput of the network significantly. This technique allows intermediate nodes to combine previous received packets to generate coded packets on the outgoing links. There are many research works to maximize the throughput of WMN based on this technique. For example, Katti et al. proposed COPE [1], a scheme that improves the network throughput by detecting coding opportunities.

¹ School of Information Science, Japan Advanced Institute of Science and Technology (JAIST), 1-1 Asahidai, Nomi, Ishikawa 923-1292, Japan

² School of Computer Science, Fudan University, 825 ZhangHeng Road, Pudong District Shanghai 201203

Our research is based on 802.11a standard. In such networks, to avoid the collision which could decrease the system performance, usually data communication is based on CSMA/CA scheme. So far, this scheme has been written in 802.11 standard since it can provide high reliability. But one drawback of this scheme is that it could not provide high throughput since data transmission in this scheme uses a direct connection with a low data rate. In our research, we propose a novel scheme, called coding-aware 2-hop path selection protocol (CA-2PSP) which uses network coding technique on the data transmission through the MAC relaying strategy in which data can be sent faster using adaptive rate control capability of IEEE 802.11a. We simulate the throughput variability of each wireless system (*e.g.*, CSMA/CA and CA-2PSP), which investigate how our proposed scheme can improve the throughput as compared to CSMA/CA scheme. Numerical and simulation results show that CA-2PSP can improve the throughput significantly compared to CSMA/CA scheme.

The structure of this paper is organized as follows. Section 2 briefly reviews the related work of the research. Section 3 describes the conventional and proposed protocols. Throughput analysis is presented in Section 4. Section 5 gives the simulation setup, scenario and results. Finally, the concluding remarks are drawn in Section 6.

2. Related Work

Katti et al. proposed Coding Opportunistically (COPE) [1] scheme, COPE is the first practical and representative network coding based scheme for WMNs to increase the throughput of the network. In COPE, every node uses Expected Transmission Count (ETX) to discover routes and then finds the coding opportunities according to the basic coding topologies (chain topology and “X” topology) when forwarding packets. If node can find there exists coding opportunity, it will code the packets. S. Chachulski et al. presented MAC-independent Opportunistic Routing and Encoding (MORE) [2] scheme. This scheme exploits random linear network coding in packet transmitting, which could eliminate the possibility of useless duplicated transmission. S. Katti et al. presented MIXIT [3], a coding technique at symbol-level. In contrast to traditional packet level network coding, Symbol-Level Network Coding (SLNC) allows intermediate nodes to combine packets at symbol level, where a symbol is typically composed of several physical layer symbols. This technique can provide better error tolerance thus can mit-

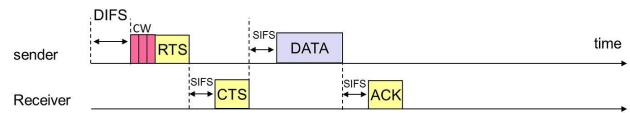

Fig. 1 CSMA/CA scheme

igate the impact of lossy links.

3. Protocol Description

3.1 Conventional CSMA/CA Scheme

Before describing our proposed scheme, first of all we checked the conventional scheme CSMA/CA. As showed in Fig 1, the sender wishes to send a DATA frame have to sense the channel at first. If the channel remains idle for a Distributed InterFrame Space (DIFS) interval, the sender generates a random back-off timer chosen uniformly in the range of $[0, CW]$, where CW is referred to as the contention window. At the first transmission attempt, CW is set to the minimum contention window (CW_{min}). After the backoff time reach to zero, the sender transmits a Request to Send (RTS) message. When the receiver receives the RTS, it transmits a Clear to Send (CTS) message after a Short InterFrame Space (SIFS) interval. The sender then is allowed to transmit its DATA frame after a time interval corresponding to a SIFS, after successful reception of the CTS frame. At last, when the receiver receives the DATA frame sent by the sender correctly, an Acknowledgment (ACK) message is replied to the sender. By using this method, all nodes including hidden nodes can defer their transmission in an appropriate way to avoid collision. Finally, a back-off procedure scheme is used for each unsuccessful transmission according to the following equation:

$$Backoff = CW \cdot Random \cdot Slottime \quad (1)$$

In this equation, CW is an integer between CW_{min} and CW_{max} , typical values being 31 and 1023, respectively. $Random$ is a random number between 0 and 1. $Slot\ time$, is fixed as $9\ \mu s$ for a given physical transmission scheme since we use 802.11a standard in this research.

3.2 Proposed CA-2PSP Scheme

We consider a wireless network based on IEEE 802.11a, which can support transmission rates of 6, 9, 12, 18, 24, 36, 48, and 54 Mbps. According to the channel conditions, a packet could be sent at different transmission rates. Here we assume data can only be sent at different transmission rates, the control messages (such as RTS, CTS, and ACK) are transmitted with the base data rate,

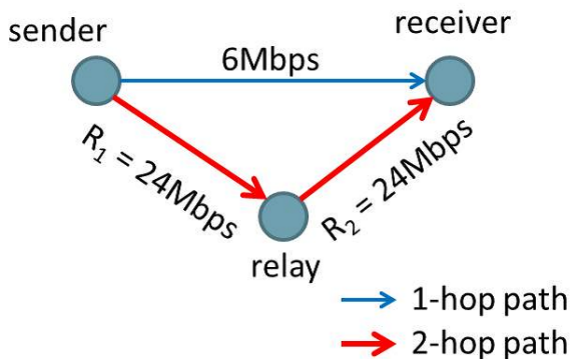

Fig. 2 2-hop path selection scheme

which is 6 Mbps.

CA-2PSP encourages a set of node to achieve higher data transmission rate. In the scenario which is showed in Figure 2, sender can reach a receiver within the 1-hop path at the basic rate (6 Mbps) and it also can reach the receiver via a relay at the higher transmission rates, here we assume the higher data rate is 24 Mbps. At the same time, coding technique is performed at the sender to compress the data. Since there are a lot of coding technique can be used to compress the data, in this paper, we perform Slepian Wolf coding [6] technique that can reduce the data size to 2/3 of the original data.

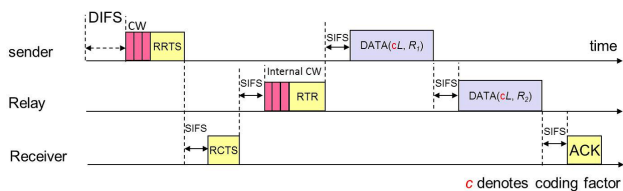

Fig. 3 CA-2PSP scheme

In our proposed scheme, we define three new packets called relay RTS (RRTS) and relay CTS (RCTS) and Ready to Relay (RTR) messages. These three messages are sent at the base rate. Fig 3 shows a sequence of handshaking diagram for the proposed CA-2PSP scheme. When the sender wants to send the data to the receiver, waiting for DIFS+CW time period, then it transmits an RRTS. After the receiver receives the RRTS message correctly, it replies the sender with an RCTS. The time interval called Internal CW is used to perform a relay node selection procedure. A node that succeeds as a relay is permitted to send a RTR message at the base data rate. An additional time slot is required to accommodate the RTR message. This message contains the important information for data rate selection and network coding performance in each channel. Prior to the RTR transmission,

the relay node determines a suitable pair of higher data rates and coding situation depending on the signal quality of overheard RRTS and RCTS message from the sender and the receiver, respectively. We will introduce our channel modeling method in section 4

When the sender decode the RTR message correctly, the sender transmits the compressed DATA1 with coding factor c with the new data rate (R_1). Then, the succeeding relay node relays the DATA2 packet immediately to the receiver with the other new data rate (R_2). Finally, the receiver will complete the transmission process by replying an ACK message at the base rate.

4. Throughput Analysis

In this section, we introduce the Network Coding techniques which are used in our research. After that, we describe the wireless channel modeling methodology.

4.1 Network Coding Technique

Network coding was applied in wireless networks in [1], taking the inherent wireless communication characteristics into account. The idea of this work is to use the shared wireless medium and exploit the packets which are not intended to a node while performing network coding. In other words, nodes overhear the neighboring transmissions and collect packets to encode and transmit accordingly. The idea is illustrated in Fig. 4.

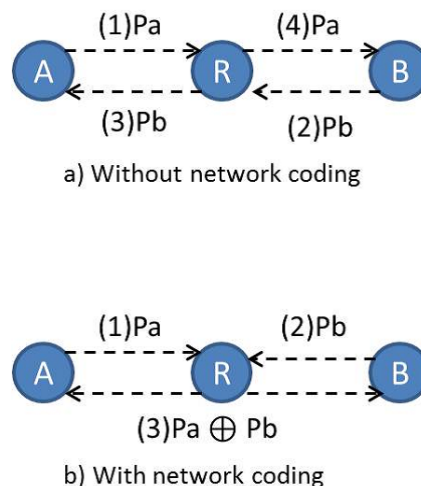

Fig. 4 Improvement of throughput gain using network coding

Node A wants to transmit a packet P_a to Node B and Node B wants to transmit packet P_b to node A via the relay node R. In the general relaying setting Node A transmits P_a and Node R relays it to be reaching B with two transmissions. P_b to reach A costs the same number of

transmission adding up the total number of transmissions to 4. In the network coding setting, Node R can perform a simple XOR operation on the two packets instead of just relaying the transmission and then broadcast the packets. Once Node A and Node B receive the XORed packet, they can decode the packets intended to be received by them. Thus with the simple XOR based network coding scheme saves a single transmission improving the throughput of the network for the above communication setting.

In the physical layer, the data is represented as bit, “0” and “1”. Meanwhile, Slepian-Wolf Coding (SWC) [6] deals with the lossless compression of two or more correlated data streams. In the best-known variation, each of the correlated streams is encoded separately and the compressed data from all these encoders are jointly decoded by a single decoder for two correlated streams. Therefore we call SWC is a form of distributed source coding.

We assume there are two joint distributed source code word (X, Y) are produced by discrete random variables with the coding rate R_1 and R_2 . The admissible rate region for the pair of rates, (R_1, R_2) is the set of points that satisfy the three inequalities:

$$R_1 \geq H(X | Y) \quad (2)$$

$$R_2 \geq H(Y | X) \quad (3)$$

$$R_1 + R_2 \geq H(X, Y) \quad (4)$$

In our research, we divide one packet into two parts uniformly (half) and encode the packet in the source node since we only have one source node. We deal with the one source node as two joint distributed bit streams. By this way, we can employ SWC to the one source node. The SWC specifies the set of rates that allow the decoder to reconstruct these correlated data streams with arbitrarily small error probability. The compression ratio is upper bounded 2/3. The detailed proof can be found in [6].

4.2 Channel Modeling Methodology

We begin by computing a fixed and independent probability τ for a node to be transmitting an RTS (RRTS) frame in a slot. To do this, we need to model the back-off algorithm. The state of a node consists of its backoff counter value and the backoff counter stage. We represent it by an ordered pair $\pi_{(a,b)}$, where a is the backoff stage in which the node is present, and b is the backoff counter value. The Markov Chain with all the states is shown in Fig.6, and is based on Bianchi Model [8] developed by G. Bianchi. In [8], τ is derived $\tau = \sum_{i=0}^m \pi_{i,0}$. By this way, we

have done the simulations for monitoring the throughput variation with respect to τ . The detailed simulation results are provided in section 5.

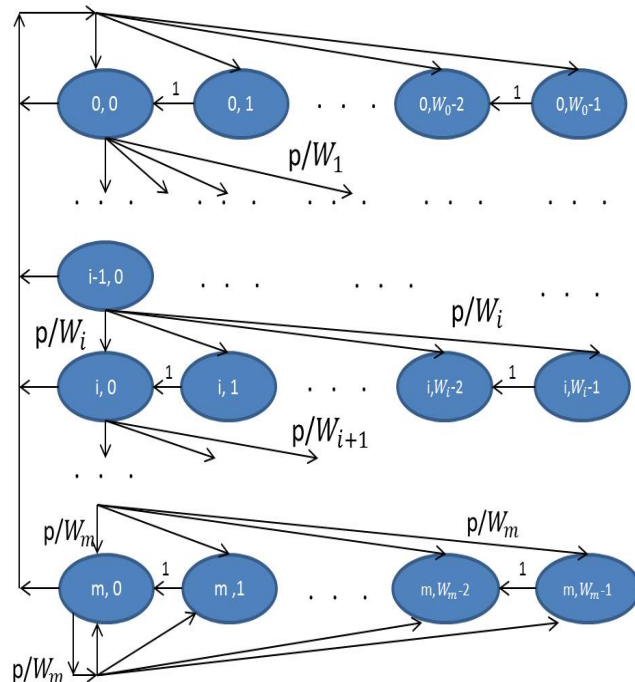

Fig. 5 Bianchi model [8] of backoff mechanism scheme

In the second step, we model the wireless channel where the nodes are all collocated, We compute the system throughput of CSMA/CA and CA-2PSP by using the Gilbert-Elliot channel model (two-state Markov Chain model) [5], as showed in Fig. 6.

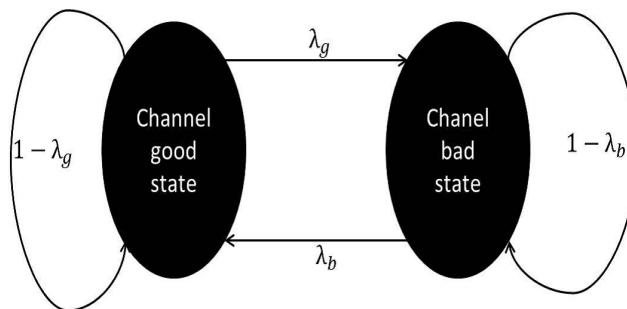

Fig. 6 Gilbert-Elliot model of wireless channel

We model the wireless channel assuming it at any time is undergoing one of the following events. For CSMA/CA, the following events is considered: Successful packet transmission by one of the n nodes, RTS-RTS frame collision of two or more stations transmitting RTS frames in the same slot, RTS corruption, CTS frame corruption, DATA frame corruption, ACK frame corruption. While CA-2PSP, we have the following events: Successful packet transmission by one of the n nodes, RRTS-RRTS frame collision of two

Table 1 Durations and probabilities for channel states (CSMA/CA)

Situation	Scenario	Duration(d_i)	Probability(p_i)
1	RTS collision	$RTS + \delta + EIFS$	$1 - (1 - \tau)^n - n\tau(1 - \tau)^{n-1}$
2	RTS corruption	$RTS + \delta + EIFS$	$n\tau(1 - \tau)^{n-1} \left(1 - \frac{\lambda_b}{\lambda_g + \lambda_b} e^{-\lambda_g(RTS + \delta)}\right)$
3	CTS corruption	$RTS + \delta + SIFS + CTS + \delta + EIFS$	$A(\tau, n)$
4	DATA corruption	$RTS + \delta + SIFS + CTS + \delta + SIFS + DATA + \delta + SIFS + ACK + \delta + DIFS$	$B(\tau, n)$
5	ACK corruption	$RTS + \delta + SIFS + CTS + \delta + SIFS + DATA + \delta + SIFS + ACK + \delta + DIFS$	$C(\tau, n)$
6	Successful	$RTS + \delta + SIFS + CTS + \delta + SIFS + DATA + \delta + SIFS + ACK + \delta + DIFS$	$1 - \sum_{i=1}^5 p_i$

or more stations transmitting RRTS frames in the same slot, RRTS corruption, RCTS frame corruption, DATA1 frame corruption, DATA2 frame corruption, ACK frame corruption.

4.3 Modeling Process

With considering all of the events that might occur in a wireless channel, the probabilities and durations for CSMA/CA are provided in Table 1. The quantity δ is used to denote the propagation delay. If $S(t)$ represents the channel state at time t , then $\Pr(\text{channel state good at CTS start} \mid \text{It was good at RTS}) = \Pr(S(t + SIFS) = \text{Good} \mid S(t) = \text{Good}) = B^T e^{A(SIFS)} B$, where $A = \begin{vmatrix} -\lambda_g & \lambda_g \\ \lambda_b & -\lambda_b \end{vmatrix}$ and $B = \begin{pmatrix} 1 \\ 0 \end{pmatrix}$.

$$A(\tau, n) = n\tau(1 - \tau)^{n-1} \frac{\lambda_b}{\lambda_g + \lambda_b} e^{-\lambda_g(RTS + \delta)} \left((1 - B^T e^{A(SIFS)} B) + B^T e^{A(SIFS)} B (1 - e^{-\lambda_g(CTS + \delta)}) \right) \quad (5)$$

$$B(\tau, n) = n\tau(1 - \tau)^{n-1} \frac{\lambda_b}{\lambda_g + \lambda_b} e^{-\lambda_g(RTS + \delta)} \left((1 - ((1 - B^T e^{A(SIFS)} B) + B^T e^{A(SIFS)} B (1 - e^{-\lambda_g(CTS + \delta)}))) \right) \left((1 - B^T e^{A(SIFS)} B) + B^T e^{A(SIFS)} B (1 - e^{-\lambda_g(DATA + \delta)}) \right) \quad (6)$$

$$C(\tau, n) = n\tau(1 - \tau)^{n-1} \frac{\lambda_b}{\lambda_g + \lambda_b} e^{-\lambda_g(RTS + \delta)} \left((1 - ((1 - B^T e^{A(SIFS)} B) + B^T e^{A(SIFS)} B (1 - e^{-\lambda_g(CTS + \delta)}))) \right) \left((1 - ((1 - B^T e^{A(SIFS)} B) + B^T e^{A(SIFS)} B (1 - e^{-\lambda_g(DATA + \delta)}))) \right) \left((1 - B^T e^{A(SIFS)} B) + B^T e^{A(SIFS)} B (1 - e^{-\lambda_g(ACK + \delta)}) \right) \quad (7)$$

Then, the system throughput for CSMA/CA can be computed as follows:

$$CSMA/CA = \frac{p_6 \cdot DATA}{\sum_{i=1}^6 p_i \cdot d_i} \quad (8)$$

The events that might occur in a wireless channel, the durations and probabilities for channel states are provided in Table 2 are considered in our proposed scheme, CA-2PSP.

$$F(\tau, n) = n\tau(1 - \tau)^{n-1} \frac{\lambda_b}{\lambda_g + \lambda_b} e^{-\lambda_g(RRTS + \delta)} \left((1 - B^T e^{A(SIFS)} B) + B^T e^{A(SIFS)} B (1 - e^{-\lambda_g(RCTS + \delta)}) \right) \quad (9)$$

$$G(\tau, n) = n\tau(1 - \tau)^{n-1} \frac{\lambda_b}{\lambda_g + \lambda_b} e^{-\lambda_g(RRTS + \delta)} \left((1 - ((1 - B^T e^{A(SIFS)} B) + B^T e^{A(SIFS)} B (1 - e^{-\lambda_g(RCTS + \delta)}))) \right) \left((1 - B^T e^{A(SIFS + CW')} B) + B^T e^{A(SIFS)} B (1 - e^{-\lambda_g(RTR + \delta)}) \right) \quad (10)$$

$$H(\tau, n) = n\tau(1 - \tau)^{n-1} \frac{\lambda_b}{\lambda_g + \lambda_b} e^{-\lambda_g(RRTS + \delta)} \left((1 - ((1 - B^T e^{A(SIFS)} B) + B^T e^{A(SIFS)} B (1 - e^{-\lambda_g(RCTS + \delta)}))) \right) \left((1 - ((1 - B^T e^{A(SIFS + CW')} B) + B^T e^{A(SIFS)} B (1 - e^{-\lambda_g(RTR + \delta)}))) \right) \left((1 - B^T e^{A(SIFS)} B) + B^T e^{A(SIFS)} B (1 - e^{-\lambda_g(DATA1 + \delta)}) \right) \quad (11)$$

Table 2 Durations and probabilities for channel states (CA-2PSP)

Situation	Scenario	Duration(d_i)	Probability(p_i)
1	RRTS collision	$RRTS + \delta + EIFS$	$1 - (1 - \tau)^n - n\tau(1 - \tau)^{n-1}$
2	RRTS corruption	$RRTS + \delta + EIFS$	$n\tau(1 - \tau)^{n-1}(1 - \frac{\lambda_b}{\lambda_g + \lambda_b} e^{-\lambda_g(RTS+\delta)})$
3	RCTS corruption	$RRTS + 2\delta + SIFS + RCTS + EIFS$	$F(\tau, n)$
4	RTR corruption	$RRTS + 3\delta + SIFS + RCTS + 2EIFS + CW' + RTR$	$G(\tau, n)$
5	DATA1 corruption	$RRTS + 6\delta + 4SIFS + RCTS + EIFS + CW' + RTR + DATA1 + DATA2 + ACK + DIFS$	$H(\tau, n)$
6	DATA2 corruption	$RRTS + 6\delta + 4SIFS + RCTS + EIFS + CW' + RTR + DATA1 + DATA2 + ACK + DIFS$	$I(\tau, n)$
7	ACK corruption	$RRTS + 6\delta + 4SIFS + RCTS + EIFS + CW' + RTR + DATA1 + DATA2 + ACK + DIFS$	$J(\tau, n)$
8	Successful	$RRTS + 6\delta + 4SIFS + RCTS + EIFS + CW' + RTR + DATA1 + DATA2 + ACK + DIFS$	$1 - \sum_{i=1}^7 p_i$

$$I(\tau, n) = n\tau(1 - \tau)^{n-1} \frac{\lambda_b}{\lambda_g + \lambda_b} e^{-\lambda_g(RRTS+\delta)} (1 - ((1 - B^T e^{A(SIFS)} B) + B^T e^{A(SIFS)} B(1 - e^{-\lambda_g(RCTS+\delta)}))) (1 - ((1 - B^T e^{A(SIFS+CW')} B) + B^T e^{A(SIFS)} B(1 - e^{-\lambda_g(RTR+\delta)}))) (1 - ((1 - B^T e^{A(SIFS)} B) + B^T e^{A(SIFS)} B(1 - e^{-\lambda_g(DATA1+\delta)}))) (1 - B^T e^{A(SIFS)} B) + B^T e^{A(SIFS)} B(1 - e^{-\lambda_g(DATA2+\delta)})$$

$$J(\tau, n) = n\tau(1 - \tau)^{n-1} \frac{\lambda_b}{\lambda_g + \lambda_b} e^{-\lambda_g(RRTS+\delta)} (1 - ((1 - B^T e^{A(SIFS)} B) + B^T e^{A(SIFS)} B(1 - e^{-\lambda_g(RCTS+\delta)}))) (1 - ((1 - B^T e^{A(SIFS+CW')} B) + B^T e^{A(SIFS)} B(1 - e^{-\lambda_g(RTR+\delta)}))) (1 - ((1 - B^T e^{A(SIFS)} B) + B^T e^{A(SIFS)} B(1 - e^{-\lambda_g(DATA1+\delta)}))) (1 - ((1 - B^T e^{A(SIFS)} B) + B^T e^{A(SIFS)} B(1 - e^{-\lambda_g(DATA2+\delta)}))) (1 - B^T e^{A(SIFS)} B) + B^T e^{A(SIFS)} B(1 - e^{-\lambda_g(ACK+\delta)})$$

(13)

Then, the system throughput for CA-2PSP is computed as follows:

$$CA - 2PSP = \frac{p_8 \cdot DATA}{\sum_{i=1}^8 p_i \cdot d_i} \quad (14)$$

5. Numerical Simulation

5.1 Simulation Setup and Environment

The scheme is evaluated the throughput improvement. MATLAB is used as the simulation tool in this study. The throughput results of scheme CSMA/CA and CA-2PSP is simulated and compared. The parameters used to obtain the numerical results are summarized in Table 3. In these simulations, the physical and MAC headers is assumed to be same as IEEE 802.11a. These headers are transmitted at the basic data rate of 6 Mbps, the higher data rate for the relay path is 24 Mbps identically. We also assume that all the nodes are identical, uniformly, and independently distributed in a two-dimensional square consists of finite number n of contending nodes.

5.2 Simulation Results

First, the relationship between τ and system throughput was determined through the simulation of the system throughput variation based on Bianchi model. The model

Table 3 Simulation parameters and settings

Parameter	Value
Hardware specification	IEEE 802.11a OFDM
RTS, RRTS size	20 bytes
CTS, ACK size	14 bytes
RCTS RTR size	15 bytes
MAC header	32 bytes
PLCP preamble size	120 bits
PLCP header size	24 bits
Slot time	9 μ s
DIFS	34 μ s
SIFS	16 μ s
CW, Internal CW	15, 5
R_1, R_2	24 Mbps
R_{dir}	6 Mbps

with number of nodes 5, 10, 20, and 50 with the data size of 2500 bytes is simulated and the result is showed in Fig. 7.

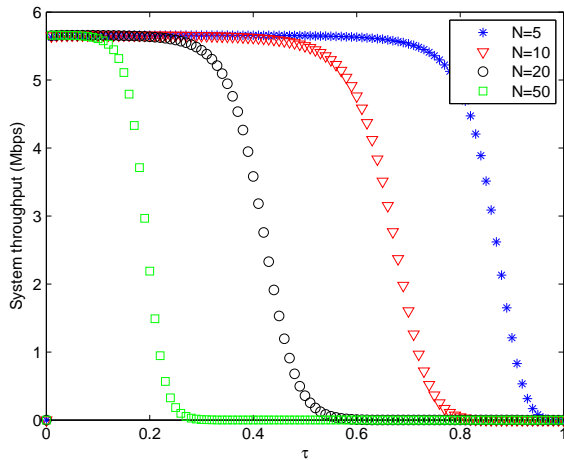

Fig. 7 System throughput versus τ

According to Fig. 7, when $\tau = 0$, there is no system throughput. But when τ is increased, for example, $\tau = 0.01$, the throughput increases sharply and reaches the maximum throughput value. After that, the system throughput decreases dramatically since RTS collision happens frequently. In this figure, we also can reveal that the system throughput decrease while the number of nodes number increases.

The throughput variations of CSMA/CA and CA-2PSP with data size of 2500 bytes and 10 number of nodes is simulated and showed in Fig. 8.

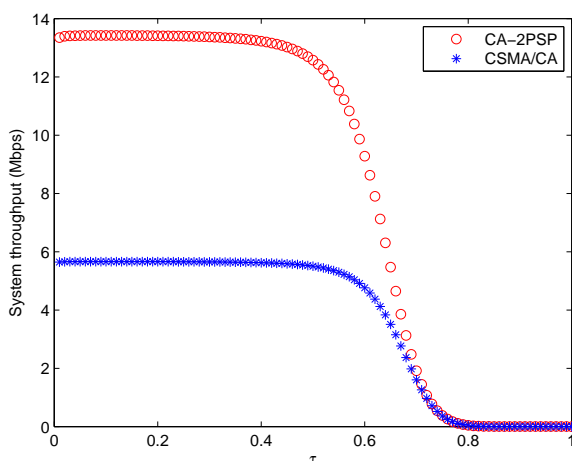

Fig. 8 System throughput versus τ

From Fig. 8, we can know that CA-2PSP outperforms significantly compared to CSMA/CA. When $\tau = 0.1$, the system throughput improvement is 110.8%.

Then, the system throughput with and without considering the two-state channel modeling Markov process which is described in section 4 is simulated. In this simulation, the number of nodes in the network is 10, the bad state time period is 10 ms, and τ is 0.1. The simulation result is showed in Fig. 9.

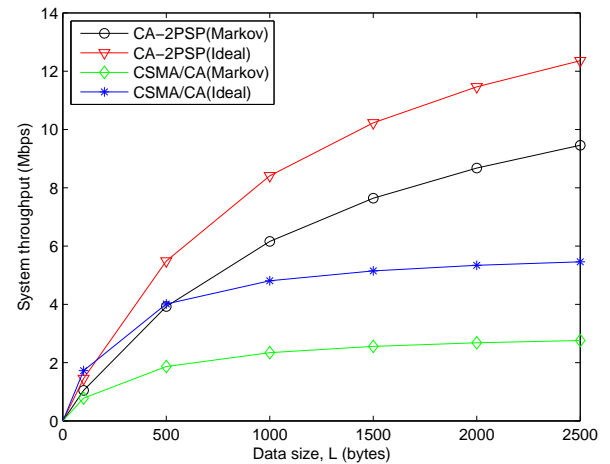

Fig. 9 System throughput versus data size

Fig. 9 reveal that with considering the channel condition which is modeled by the two-state Markov model, the system throughput decreases significantly. The decrement value on the data size of 2500 bytes is sampled and result to the decrement proportion for CSMA/CA is 49.4%, for CA-2PSP is 23.5%.

After that, the channel condition that according to the two-state Markov model is simulated. The packet size is fixed 2500 bytes, $\tau = 0.02$, good state period equal to 100 ms, bad state time period equal to 10 ms. The result is showed in Fig. 10.

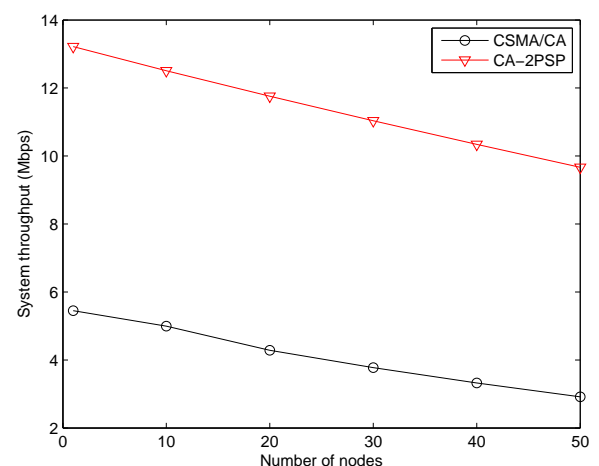

Fig. 10 System throughput versus number of nodes

From Fig. 10, we know that when the node number increase, the system throughput decrease. This is because when the nodes in the network increase, they all have a probability of 0.02 to send a RTS to capture the channel, if it exists two stations contend the channel, then both of them will fail to the channel capture.

Finally, the throughput changing with respect to the bad state time period is simulated. In this simulation, the data size is 2500 bytes, node number equal to 10, $\tau = 0.1$, good state time period equal to 100 ms. The result of system throughput variation changing the bad state time period from 1 ms to 100 ms, is showed in Fig. 11.

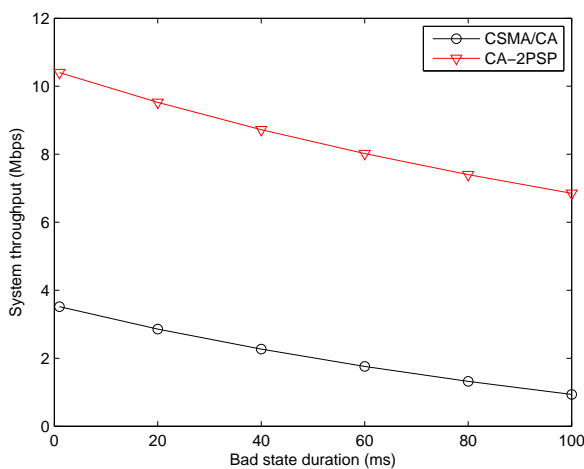

Fig. 11 System throughput versus bad state duration

Fig. 11 shows that the longer of the bad state time period, the worse system performance. From all of the simulation results, they prove is that our proposed scheme outperforms CSMA/CA significantly.

6. Concluding Remarks

In this paper, we have addressed the throughput degradation problem of WMN and advocate that network coding technique can provide an elegant solution that can improve the network throughput. Meanwhile, a novel scheme call CA-2PSP, which combines the adaptive rate control capability of IEEE 802.11a MAC protocol and network coding technique is developed. Numerical simulations reveal that our proposed scheme can improve the network throughput significantly compared to CSMA/CA.

References

[1] S. Katti, D. Katabi, W. Hu, H. Rahul, and M. Medard, "XORs in the air: Practical wireless network coding," *IEEE/ACM Trans. on Networking*, vol. 16, no. 3, pp.

497–510, 2008.
 [2] S. Chachulski, M. Jennings, S. Katti, and D. Katabi, "Trading structure for randomness in wireless opportunistic routing," *ACM Special Interest Group on Data Commun. (SIGCOMM)*, vol. 37, pp. 169–180, 2007.
 [3] S. Katti, D. Katabi, H. Balakrishnan, and M. Medard, "Symbol-level network coding for wireless mesh networks," *ACM Special Interest Group on Data Commun. (SIGCOMM)*, vol. 38, no. 4, pp. 401–412, 2008.
 [4] A.O. Lim and S. Yoshida, "A 2-hop path selection protocol (2PSP) in multi-rate ad hoc wireless networks," *IEICE Trans. on Commun.*, vol. E90-B, no. 1, pp. 43–50, 2007.
 [5] N. Gupta and P.R. Kumar, "A performance analysis of the 802.11 wireless LAN medium access control," *Commun. in Inf. and Systems*, vol. 3, no. 4, pp. 279–304, 2004.
 [6] D. Slepian and J.K. Wolf, "Noiseless coding of correlated information sources," *IEEE Trans. Inf. Theory*, vol. IT-19, no. 4, pp. 471–480, 1973.
 [7] R. Ahlswede, N. Cai, S.R. Li, and R.W. Yeung, "Network information flow," *IEEE Trans. on Inf. Theory*, vol. 46, no. 4, pp. 1204–1216, 2000.
 [8] G. Bianchi, "Performance analysis of the IEEE 802.11 distributed coordination function," *IEEE J. on Selected Area in Commun.*, vol. 18, no. 3, pp. 535–547, 2000.