

Title	Simple Relay Systems with BICM-ID Allowing Intra-link Errors
Author(s)	Cheng, Meng; Zhou, Xiaobo; Anwar, Khoirul; Matsumoto, Tad
Citation	IEICE TRANSACTIONS on Communications, E95-B(12): 3671-3678
Issue Date	2012-12-01
Type	Journal Article
Text version	publisher
URL	http://hdl.handle.net/10119/11352
Rights	Copyright (C) 2012 The Institute of Electronics, Information and Communication Engineers (IEICE). Meng Cheng, Xiaobo Zhou, Khoirul Anwar and Tad Matsumoto, IEICE TRANSACTIONS on Communications, E95-B(12), 2012, 3671-3678. http://dx.doi.org/10.1587/transcom.E95.B.3671
Description	



Simple Relay Systems with BICM-ID Allowing Intra-Link Errors

Meng CHENG^(†a), Xiaobo ZHOU^(†b), *Nonmembers*, Khoirul ANWAR^(†c), and Tad MATSUMOTO^(†,†d), *Members*

SUMMARY In this work, a simple doped accumulator (DACC)-assisted relay system is proposed by using bit-interleaved coded modulation with iterative decoding (BICM-ID). An extrinsic information transfer (EXIT) chart analysis shows that DACC keeps the convergence tunnel of the EXIT curves open until almost the (1, 1) point of the mutual information, which avoids the error floor. In the relay system, errors may happen in the source-relay link (intra-link), however, they are allowed in our proposed technique where the correlation knowledge between the source and the relay is exploited at the destination node. Strong codes are not needed and even the systematic source bits can be simply extracted at the relay even though the systematic part may contain some errors. Hence, the complexity of the relay can be significantly reduced, and thereby the proposed system is energy-efficient. Furthermore, the error probability of the intra-link can be estimated at the receiver by utilizing the *a posteriori* log-likelihood ratios (LLRs) of the two decoders, and it can be further utilized in the iterative processing. Additionally, we provide the analysis of different relay location scenarios and compare the system performances by changing the relay's location. The transmission channels in this paper are assumed to suffer from additive white Gaussian noise (AWGN) and block Rayleigh fading. The theoretical background of this technique is the Slepian-Wolf/Shannon theorem for correlated source coding. The simulation results show that the bit-error-rate (BER) performances of the proposed system are very close to theoretical limits supported by the Slepian-Wolf/Shannon theorem.

key words: BICM-ID, relay system, doped accumulator, iterative decoding, correlated source

1. Introduction

The research on the cooperative communications has recently become one of the hottest topics in the wireless communication area. Generally, the transmit diversity requires more than one antenna in the transmission. However, many wireless devices are limited in size and hardware complexity. The cooperative communication technique aims to establish a virtual multi-user environment by allowing mobile users to share their antennas, which enhances data throughput, as well as power and spectral efficiencies.

The relay system, which can be seen as a simple realization of the cooperative communication structure, was first proposed by van der Meulen in [1]. In [2], a distributed

Turbo code (DTC) scheme for the relay system was proposed, which consists of three basic components, a source node, a relay node and a destination node. During the first time slot, the transmitter at the source node broadcasts the signal to both the relay and the destination nodes. With the decode-and-forward (DF) strategy, the relay decodes the signal, interleaves, re-encodes and forwards it again to the destination during the second time slot. However, in most of the works so far, like [2], the source-relay link (intra-link) is assumed to be error free. In our proposed relay system, we assume that the relay node can not always fully decode the original information bits, because errors may happen due to the noise and also fading variation of the intra-link. The error probability p_e can be seen as the correlation between the source and relay.

According to the Slepian-Wolf (SW) theorem, the distributed source coding scheme is able to achieve the same compression rate as the optimum joint encoding approach with a single encoder, by best exploiting the correlation knowledge of the source information streams. This theorem can be applied in the simple relay system, where the correlation knowledge between the source and the relay can be exploited in a log-likelihood ratio (LLR) updating function, in order to enhance the system performance. The value p_e of the intra-link channel can be estimated at the destination node by using the *a posteriori* LLRs output from the channel decoders for the codes used in the source and the relay.

In this work, we adopt bit-interleaved coded modulation with iterative decoding (BICM-ID) technique in the proposed relay system. The BICM-ID has been well studied as a bandwidth efficient coded modulation method, where the encoder and the modulator are separated by an interleaver. The extrinsic LLRs obtained from the demapper/decoder are exchanged iteratively with the decoder/demapper at the receiver side, via the de-interleaver/interleaver, respectively. The performance of the BICM-ID technique using non-Gray mapping outperforms that with the Gray mapping labeling in the iterative process, which can be analyzed based on the extrinsic information transfer (EXIT) chart [3]. Our technique shows that by combining the BICM-ID demapper with DACC [4], the demapper's EXIT curve can reach a point very close to the (1,1) mutual information point, which avoids the error floor.

This paper is organized as follows. A simple one way relay system mode assumed in this paper is introduced in Sect. 2. The proposed decoding technique, as well as the BICM-ID scheme and the LLR updating function are de-

Manuscript received April 24, 2012.

Manuscript revised August 6, 2012.

[†]The authors are with the School of Information Science, Japan Advanced Institute of Science and Technology (JAIST), Nomi-shi, 923-1292 Japan.

^{††}The author is with the Centre of Wireless Communications, University of Oulu, Finland.

a) E-mail: chengmeng@jaist.ac.jp

b) E-mail: xiaobo@jaist.ac.jp

c) E-mail: anwar-k@jaist.ac.jp

d) E-mail: matumoto@jaist.ac.jp

DOI: 10.1587/transcom.E95.B.3671

scribed in Sect. 3. In Sect. 4, the convergence behavior of the proposed system is evaluated using the EXIT chart analysis. The simulation results are shown in Sect. 5. Finally, the conclusions are given in Sect. 6. The subscripts \bullet_{sr} , \bullet_{sd} , and \bullet_{rd} are used to indicate the source-relay, source-destination and relay-destination links, respectively.

2. System Model

In our simple one way relay system, both the relay and the destination receive the signal from the source node during Phase 1. At the relay node, the information (systematic) bits are recovered, either by performing channel decoding or even by extracting the systematic part of the coded bits, before being re-transmitted. During Phase 2, the recovered bits (may contain some errors) are interleaved, re-encoded again and forwarded to the destination node.

Three relay location scenarios are considered in this paper, as shown in Fig. 1. Generally, the relay node can be allocated closer to the source node in Location A or closer to the destination in Location B, or the three components keep the same distance from each other in Location C. The geometric gain of the source-relay link with regard to the source-destination link can be defined as

$$G_{sr} = \left(\frac{d_{sd}}{d_{sr}} \right)^\alpha, \quad (1)$$

where the path-loss exponent α is assumed to be 3.52 [5] in our simulations. It is straightforward to derive the geometric gain of the relay-destination link G_{rd} in the same way. Moreover, without losing the generality, the geometric-gain of the source-destination link, G_{sd} , is fixed to one. Therefore the received signals y_{ij} ($ij \in \{sr, sd, rd\}$) at the relay and the destination node can be expressed as:

$$y_{sr} = \sqrt{G_{sr}} \cdot h_{sr} \cdot s + n_{sr}, \quad (2)$$

$$y_{sd} = \sqrt{G_{sd}} \cdot h_{sd} \cdot s + n_{sd}, \quad (3)$$

$$y_{rd} = \sqrt{G_{rd}} \cdot h_{rd} \cdot s_r + n_{rd}. \quad (4)$$

where s and s_r represent the symbols transmitted from the source and the relay, respectively. The fading channel gain, h_{ij} , is equal to one in the AWGN channel. The notation n_{ij} represents the zero-mean AWGN noise vector of the three links with the variance σ_{ij}^2 per dimension. The signal-to-noise ratio (SNR) of source-relay and relay-destination links

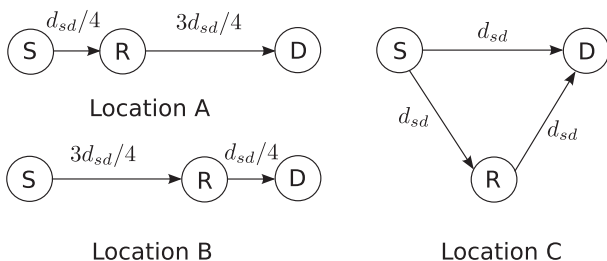

Fig. 1 System model with different relay scenarios. d_{sd} denotes the length of the source-destination link.

at each location scenario are evaluated as follows: given the path loss parameter α equals to 3.52 [5], we have $\text{SNR}_{sr} = \text{SNR}_{sd} + 21.19$ dB and $\text{SNR}_{rd} = \text{SNR}_{sd} + 4.4$ dB in Location A; $\text{SNR}_{sr} = \text{SNR}_{sd} + 4.4$ dB and $\text{SNR}_{rd} = \text{SNR}_{sd} + 21.19$ dB in Location B; $\text{SNR}_{sd} = \text{SNR}_{rd} = \text{SNR}_{sr}$ in Location C.

3. Proposed Decoding Scheme

In this section, we discuss the decoding process of our proposed relay system in detail and focus on some main techniques.

3.1 Decoding Process

The block diagram of the proposed relay system is shown in Fig. 2. In this system, we do not need strong codes: only memory-1 half rate ($R = 1/2$) systematic non-recursive convolutional code (SNRCC) is adopted for both encoders C_1 and C_2 . At the source node, the original information bits b_1 is first encoded by C_1 . After that, the encoded bit sequences are interleaved by Π_1 and doped-accumulated by DACC (with a doping rate P_{d1}). Then, they are modulated into symbols s by using the BICM scheme, and transmitted to both the relay and the destination during the first time slot.

The DACC shown in Fig. 2 has the same structure with the memory-1 half rate systematic recursive convolutional code (SRCC), the detail of which can be found in [6] and [7]. But the difference is that, the output of DACC is the systematic bits, where only every P_{d1} -th systematic bit is replaced by the corresponding coded bit within each frame. It should be noted that the DACC itself does not change the code rate. The purpose of using DACC is to reshape the EXIT curve of the demapper and keep the convergence tunnel open.

At the relay node, the received signals first go through the demapper, DACC^{-1} and the de-interleaver Π_1^{-1} . Then, the original information bits b_1 has to be recovered by making hard decisions of the output of the decoder D_1 , which is denoted as b_2 . The Maximum A-Posteriori (MAP) algorithm, proposed by Bahl, Cocke, Jelinek and Raviv (BCJR), is used to perform channel decoding of the convolutional codes and the DACC used in this work. It should be noted that the relay node does not perform iterative process for

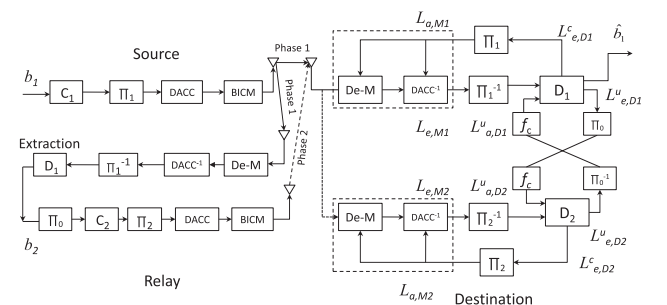

Fig. 2 The structure of the proposed relay system.

demapping and decoding for recovering the original information bits. Errors may happen at the relay, but still they are allowed, and hence high performance requirement of the intra-link is not needed with our technique. Therefore, even we only *extract* the systematic part of the bits without performing channel decoding. In this case, the complexity of the relay can be further reduced. After that, the recovered bits are interleaved by Π_0 and then go through the channel encoder C_2 , the interleaver Π_2 and the DACC (with doping rate P_{d2}). Then the data are modulated into s_r , and transmitted to the destination during the second time slot.

At the destination node, the received signals y_{sd} and y_{rd} first go through the horizontal decoding processes as can be seen in Fig. 2, where the combination of the BICM-ID demapper and the DACC exchange information with the channel decoders through horizontal iterations (HI) [4]. After every HI, the extrinsic LLRs obtained from the two decoders D_1 and D_2 are also exchanged with several vertical iterations (VI), through an LLR updating function f_c . By doing this, the extrinsic LLR (systematic part) forwarded from the relay helps decoding of the original bits by exploiting the correlation knowledge between the source and the relay. Finally, the original information can be recovered by making hard decisions of the a posteriori LLRs as the outputs of D_1 .

3.2 BICM-ID Demapper

The non-Gray pattern, rather than the Gray mapping, is quite often adopted in the BICM-ID technique. In the case of quaternary phase shift keying (4-PSK) as shown in Fig. 3, given the feedback information of the bit at the position Bit 1, the detection of the bit at Bit 0 can be performed based on the Euclidean distance between the two constellation points having different bits at the position Bit 0. It can be obviously seen that the determining Euclid distance of the set partitioning labeling pattern is longer than that of the Gray mapping’s case, when detecting the bit at the position Bit 1. Therefore, the set partitioning labeling pattern outperforms the Gray mapping in the iterative decoding process [8].

Further improvement of decoding can be achieved using the BICM-ID technique by invoking the soft-decision feedbacks from the decoder’s outputs to the demapper in the iterative process [9]. The extrinsic LLRs of v -th bit of symbol s after the demapper in the AWGN channel can be expressed as

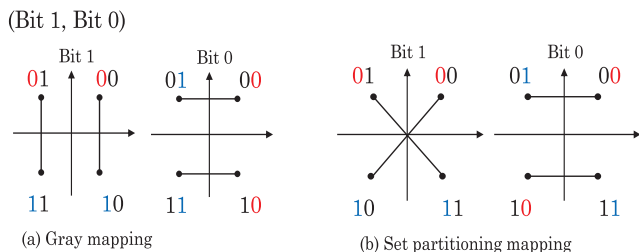

Fig. 3 Comparison of the Gray and non-Gray mapping.

$$L_e(s_v) = \ln \frac{P(s_v = 1 | y)}{P(s_v = 0 | y)} = \ln \frac{\sum_{s \in S_1} \left\{ \exp \left\{ -\frac{|y - h_{ij}s|^2}{2\sigma_{ij}^2} \right\} \prod_{w \neq v}^M \exp(s_w L_a(s_w)) \right\}}{\sum_{s \in S_0} \left\{ \exp \left\{ -\frac{|y - h_{ij}s|^2}{2\sigma_{ij}^2} \right\} \prod_{w \neq v}^M \exp(s_w L_a(s_w)) \right\}}, \quad (5)$$

where S_1 and S_0 denote the set of labelling having the v -th bit being zero or one, respectively. M represents the number of bits per symbol and $L_a(s_w)$ represents the LLRs fed back from the decoder corresponding to the w -th position of the labeling patterns. The output extrinsic LLRs of the demapper are then forwarded to the DACC decoder.

Figure 4 shows the EXIT curves with Gray mapping and non-Gray mapping for 4-PSK at 2 dB SNR. It is found that with Gray mapping pattern, the EXIT curve is entirely flat regardless of different a priori information, which means that the feedback from the decoder does not help the demapping in iterative process. By using BICM-ID technique, obviously, the EXIT curve rises up as the given a priori information increases, but still it can not achieve (1,1) mutual information point. After combining with the DACC, the tendency of the EXIT curve changes again and it finally reaches the (1,1) mutual information point, which can be well matched with the EXIT curve of the decoder. Therefore, the error floor is completely avoided by this technique. Furthermore, the shaped demapping EXIT curve with non-Gray mapping is well matched with memory-1 outer code, as shown in Fig. 4.

3.3 LLR Updating Function

As described above, our technique can improve the performance of the distributed relay system by utilizing the correlation knowledge between the source and the relay. The recovered information bits at the relay node may contain some errors, but they are still correlated with the original information. The correlation value is denoted by the error

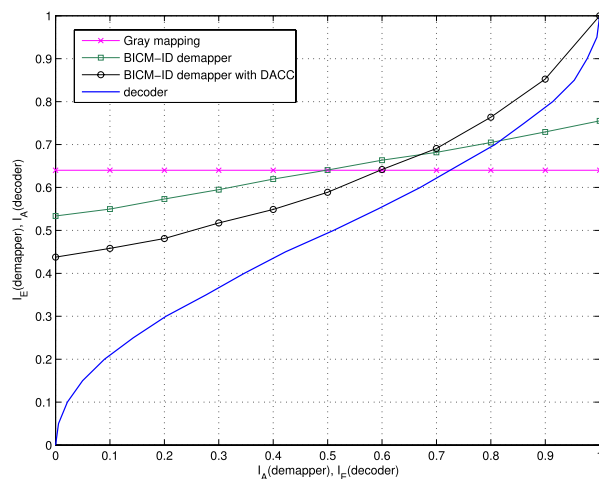

Fig. 4 EXIT chart of the BICM-ID demapper, SNR = 2 dB.

probability p_e of the intra-link, which can be estimated by using the a posteriori LLRs of the uncoded (systematic) bits, L_{p,D_1}^u and L_{p,D_2}^u , from the two decoders D_1 and D_2 , as [4]:

$$p_e = \frac{1}{N} \sum_{n=1}^N \frac{e^{L_{p,D_1}^u} + e^{L_{p,D_2}^u}}{(1 + e^{L_{p,D_1}^u})(1 + e^{L_{p,D_2}^u})}, \quad (6)$$

where N denotes the number of the a posteriori LLR pairs from the two decoders with sufficient reliability. Specifically, only the LLRs with their absolute values greater than a given threshold can be chosen. The threshold is set at 1 in our simulations, since the memory-1 code in our system is not strong [4].

After obtaining the estimated error probability p_e given by (6), we can straightforwardly derive (7) as follows [7]:

$$\begin{aligned} P(b_2 = 0) &= (1 - p_e)P(b_1 = 0) + p_eP(b_1 = 1), \\ P(b_2 = 1) &= (1 - p_e)P(b_1 = 1) + p_eP(b_1 = 0). \end{aligned} \quad (7)$$

Based on the relationship in (7), the two decoders D_1 and D_2 exchange soft LLRs by exploiting p_e through the LLR updating function f_c [10], which can be defined as follows:

$$f_c(x) = \ln \frac{(1 - p_e) \cdot \exp(x) + p_e}{(1 - p_e) + p_e \cdot \exp(x)}, \quad (8)$$

where the input value x represents the interleaved and de-interleaved extrinsic LLRs of the uncoded bits, L_{e,D_1}^u and L_{e,D_2}^u , coming from the two decoders D_1 and D_2 , respectively. The outputs of f_c are the updated LLRs by exploiting p_e as the correlation knowledge of the intra-link. Specifically, the extrinsic information of one decoder are fed to the other one as the a priori information, and the VI operations at the destination node can be expressed as:

$$L_{a,D_1}^u = f_c \left\{ \Pi_0^{-1} \left(L_{e,D_2}^u \right) \right\}, \quad (9)$$

$$L_{a,D_2}^u = f_c \left\{ \Pi_0 \left(L_{e,D_1}^u \right) \right\}. \quad (10)$$

4. EXIT Chart and Convergence Analysis

The three-dimensional (3D) EXIT analysis is provided in this section, to evaluate the convergency behaviors of the proposed relay system [10]. In this paper, we only focus on the decoder D_1 because the final target of the relay system is to successfully retrieve the original information bits b_1 . As shown in Fig. 2, the a priori LLRs of the uncoded bits L_{a,D_1}^u (the updated version of L_{e,D_2}^u) and the coded bits L_{c,D_1}^c are exploited in D_1 . Hence,

$$I_{e,D_1}^c = T_{D_1}^c(L_{a,D_1}^c, L_{e,D_2}^u, p_e), \quad (11)$$

where I_{e,D_1}^c denotes the mutual information between the output of D_1 (L_{e,D_1}^c) and the channel coded bits of D_1 . L_{e,D_2}^u denotes D_2 's extrinsic output with regard to the uncoded bits and it can be fed to D_1 as its a priori information L_{a,D_1}^u by exploiting the intra-link correlation.

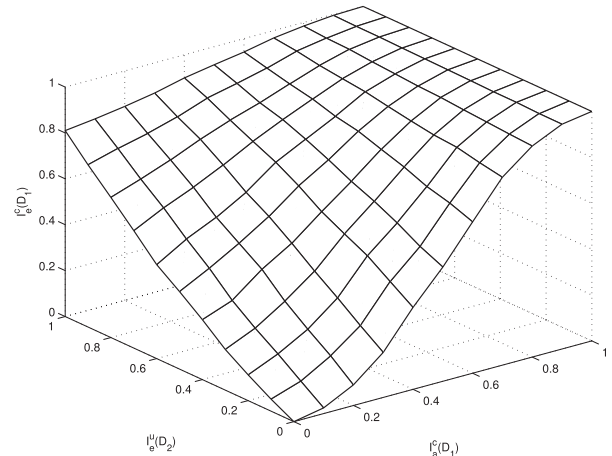

Fig. 5 3D EXIT chart, $p_e = 0.02$, $\text{SNR}_{sd} = -4.5$ dB, location A, 4-PSK.

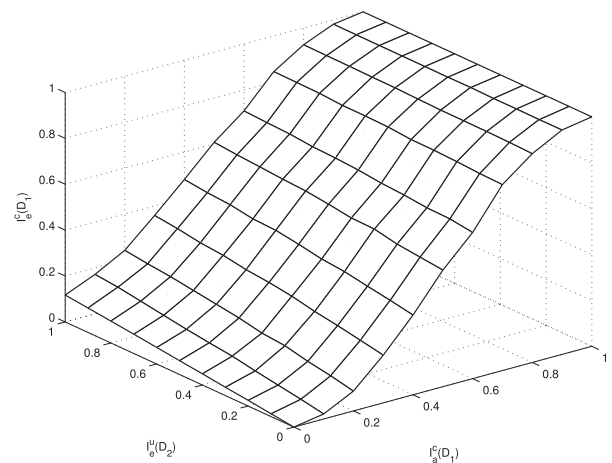

Fig. 6 3D EXIT chart, $p_e = 0.25$, $\text{SNR}_{sd} = -4.5$ dB, location A, 4-PSK.

The 3D EXIT chart can be used to examine the influence of the correlation. Figure 5 shows that when the intra-link error probability p_e is small ($p_e = 0.02$), which indicates that the source and relay are highly correlated, I_{e,D_2}^u has a significant influence on $T_{D_1}^c(\cdot)$. However, when p_e is large ($p_e = 0.25$), I_{e,D_1}^c does not increase much as I_{e,D_2}^u goes large, which can be seen in Fig. 6. Therefore, with small p_e values, the impact of D_2 has to be well examined since the decoder D_2 can provide significant help when the source and relay are highly correlated. When p_e is large, the EXIT analysis of decoder D_1 can be simplified to 2D's case, since the effect of L_{e,D_2}^u is negligible.

The convergency behaviors of the proposed relay system are presented for the Locations B and C, with modulation schemes of 4-PSK and 8-PSK, as shown in Figs. 7 to 10. We plot the EXIT charts of the decoder D_1 , as well as the combination of the BICM-ID demapper and the DACC, in the 3D EXIT chart. The trajectories of the mutual information are simulated, by measuring the exchange of the soft LLRs between D_1 and the combined BICM-ID demapper plus the DACC decoder. In our technique, given sufficient

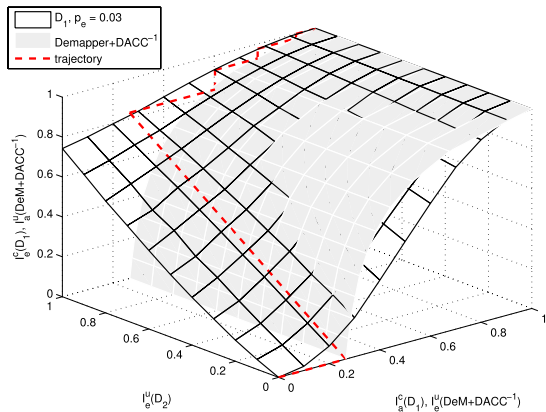

Fig. 7 3D EXIT chart and trajectory of the proposed system, location B, 4-PSK, $SNR_{sd} = -0.5$ dB.

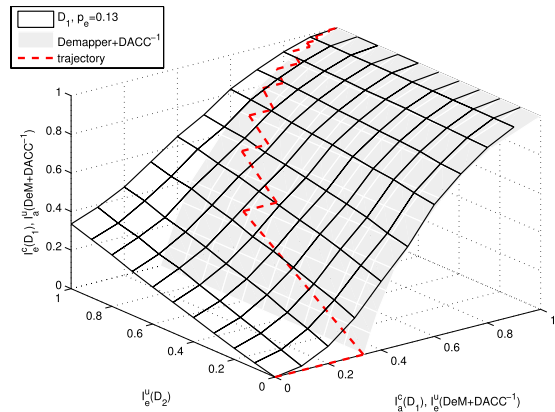

Fig. 9 3D EXIT chart and trajectory of the proposed system, location B, 8-PSK, $SNR_{sd} = 2.9$ dB.

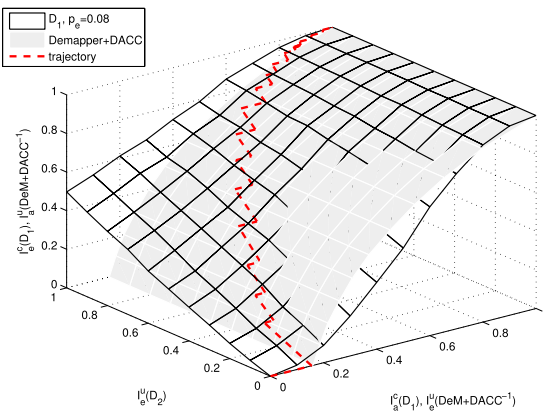

Fig. 8 3D EXIT chart and trajectory of the proposed system, location C, 4-PSK, $SNR_{sd} = 1.2$ dB.

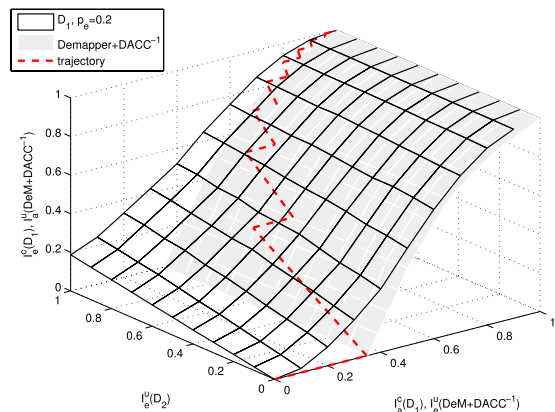

Fig. 10 3D EXIT chart and trajectory of the proposed system, location C, 8-PSK, $SNR_{sd} = 4.5$ dB.

SNR values and enough iterations, the trajectory goes between the two surfaces and can finally reach (1,1) mutual information point. Based on the 3D EXIT chart analysis, the SNR_{sd} requirements for the convergence tunnel opening in the locations A, B and C are around -4.6 dB, -0.5 dB and 1.2 dB for 4-PSK, and -2.4 dB, 2.9 dB and 4.5 dB for 8-PSK. It should be noticed that the doping rate of the DACC also has the significant impact of the EXIT curve. According to the EXIT analysis, the doping rate P_{d1} and P_{d2} are equally set at 5, 5, 3 for 4-PSK and 4, 2, 8 for 8-PSK, in scenarios A, B and C, respectively.

5. Simulation Results

Figures 12 and 13 show the BER performances of the proposed relay system with 4-PSK and 8-PSK modulations in AWGN channels, respectively, where the frame length of the transmitted information is set at 10000 bits in the simulations. Based on the EXIT analysis, 30 horizontal iterations are performed at the destination node and meanwhile 5 vertical iterations take place between the two decoders D_1 and D_2 during each horizontal iteration.

The turbo cliff can be achieved by using our technique

in the relay system over AWGN channels. It can be seen from Fig. 12 that, when performing the channel decoding at the relay node using 4-PSK, the BER performance in Location A is much better than that of the other cases. The reason is that, when the relay is close to the source, the geometric gain of the intra-link is large and the intra-link error probability p_e is very small. In other words, the recovered bits at the relay node is highly correlated with original information at the source node, and the decoder D_2 at the destination is able to provide very reliable extrinsic LLRs of the uncoded information bits, which can be fed into the decoder D_1 as the *a priori* information after performing the f_c function. Hence, the Location C's case has the worst BER performance because there is no geometric gain when the source, relay and destination nodes are equally separated.

On the other hand, Fig. 12 also presents the BER curves by using extract-and-forward (EF) relay strategy, where only the systematic part of the coded bits are extracted, without performing channel decoding. According to Fig. 11, it can be clearly seen that the intra-link BER performance of the EF scheme is worse than that of the DF scheme, for both 4-PSK and 8-PSK cases. However, it has to be noted that the EF scheme can achieve almost the same BER performance

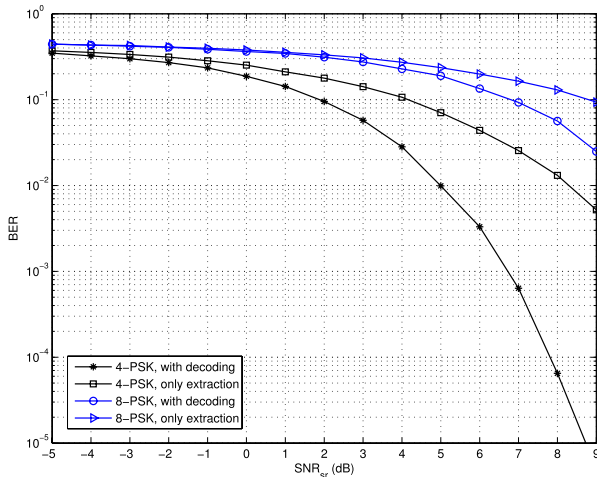

Fig. 11 BER performances of the intra-link using channel decoding or only extraction.

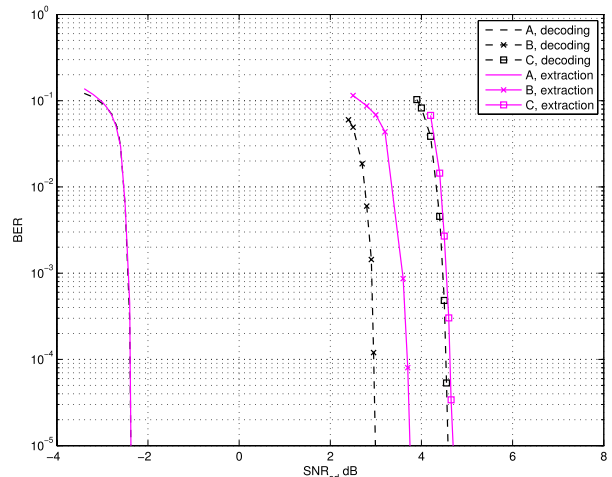

Fig. 13 BER performances of the proposed system, 8-PSK.

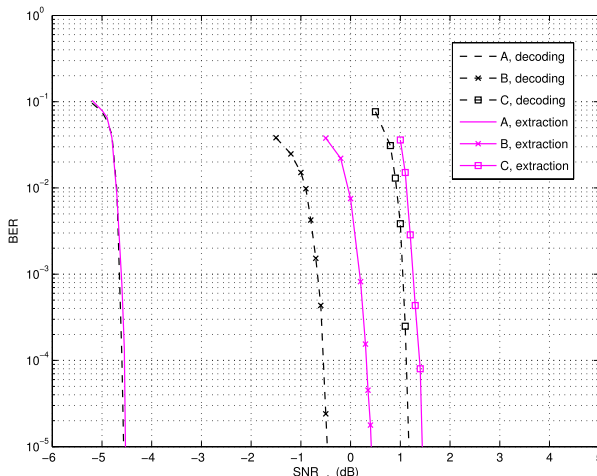

Fig. 12 BER performances of the proposed system, 4-PSK.

as that of the DF case with our proposed relay system in Location A, as shown in Fig. 12. This is because that the intra-link is very strong when the relay is close to the source node, and both of the DF and EF strategies can almost fully recovered the original bits at the relay. When the relay node is close to the destination as in Location B, there is only about 1 dB gap between the BER curves of DF and EF schemes. In the case of Location C, the BER gap between DF and EF is much less than that of Location B's case. The reason is that, for Location C, when the SNR_{sd} is around 1.2 dB ($SNR_{sr} = SNR_{sd}$), the intra-link BER gap between DF and EF schemes is very small, as shown in Fig. 11. However, in Location B, when SNR_{sd} is around 0 dB ($SNR_{sr} = SNR_{sd} + 4.4$ dB), the intra-link BER gap is much larger than that of Location B. In this sense, EF can also achieve very good performance and therefore the complexity of the relay can be further reduced by using the EF scheme. Similarly, the BER performances for the 8-PSK modulation scheme are presented in Fig. 12 over AWGN channels.

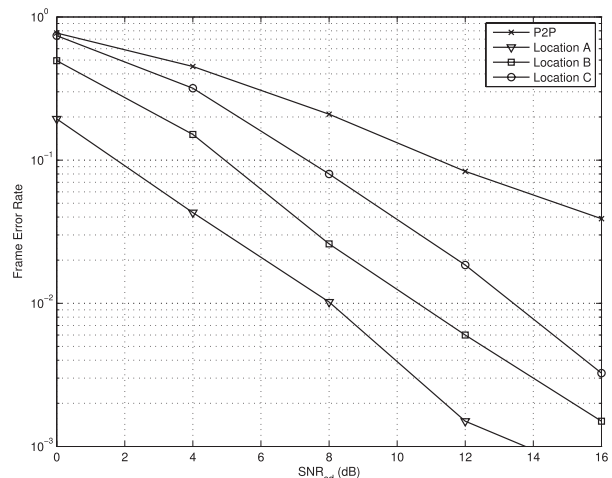

Fig. 14 FER performances of the proposed system, 4-PSK.

It can be seen in Fig. 12 and Fig. 13 that, when the three components in the proposed relay system are equally separated as in Location C, the SNR threshold happens at low SNR values for both with 4-PSK and 8-PSK modulations. Hence, it is reasonable to rely on the Shannon/SW limit calculation using the Gaussian codebook. According to [11], the Shannon/SW limit with Gaussian codebook is -1.55 dB for 4-PSK and 1.61 dB for 8-PSK cases, both with the coding rate being $1/2$. Therefore, the gaps with our proposed system to the limit in the location C are 2.75 dB and 2.89 dB for 4-PSK and 8-PSK, respectively.

Finally, the frame-error-rate (FER) performance in block Rayleigh fading channels using 4-PSK and 8-PSK modulation schemes are shown in Figs. 14 and 15. The interleaver lengths are set at 4400 and 4500 bits for 4-PSK and 8-PSK cases, respectively. The doping rate of the DACCs are set the same as in the AWGN channel's cases for Location A, B and C. The point-to-point (P2P) transmissions are simulated for comparison, where BICM-ID and DACC are also used. Similar to the AWGN channel's cases, the pro-

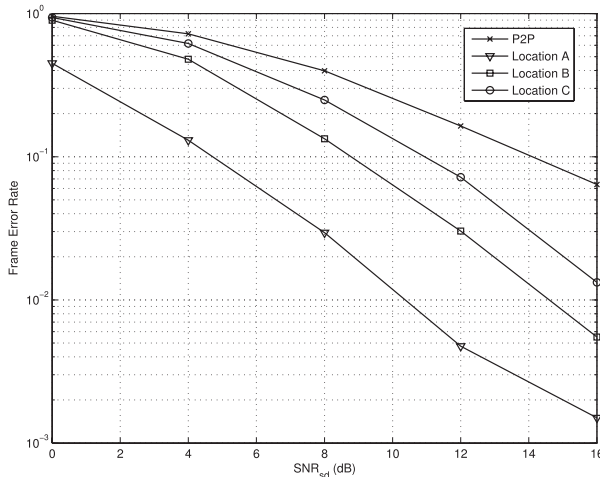

Fig. 15 FER performances of the proposed system, 8-PSK.

posed system achieves better FER performance when the relay is closer to the source.

6. Conclusions

The major aim of this paper has been to apply higher order modulation for higher spectrum efficiency in relaying systems with a very simple structure. We have proposed a novel technique that combines the BICM-ID technique with higher order modulation, where block fading is assumed. The novelty of the proposed structure lies in the fact that the relay allows the errors, due to the fading variation of the intra-link, remaining in the original information. Moreover, the knowledge of intra-link error probability is used as the correlation between source and relay nodes. The correlation can be estimated and further exploited at the destination via the vertical iteration. It has been found that, the EXIT curve of demapper combined with DACC⁻¹ exhibits excellent matching with the memory-1 convolutional codes with the help of vertical iteration at the destination. Thereby, close-limit BER performances can be achieved without requiring high computational complexity.

Acknowledgments

This research is supported in part by the Japan Society for the Promotion of Science (JSPS) Grant under the Scientific Research (C) No. 22560367 and in part (B) No. 23360170. The authors are highly thankful for valuable suggestions given by Mr. Xin He, who is with Japan Advanced Institute of Science and Technology (JAIST).

References

- [1] E.C. van der Meulen, "Three-terminal communication channels," *Adv. Appl. Prob.*, vol.3, pp.120–154, June 1971.
- [2] B. Zhao and M.C. Valenti, "Distributed turbo coded diversity for relay channel," *Electron Lett.*, vol.39, pp.786–787, May 2003.
- [3] S. ten Brink, "Convergence behavior of iteratively decoded parallel concatenated codes," *IEEE Trans. Commun.*, vol.49, pp.1727–1737,

Oct. 2001.

- [4] K. Anwar and T. Matsumoto, "Accumulator-assisted distributed turbo codes for relay system exploiting source-relay correlation," *IEEE Commun. Lett.*, vol.16, no.7, pp.1114–1117, July 2012.
- [5] R. Youssef and A. Graell i Amat, "Distributed Serially Concatenated Codes for Multi-source Cooperative Relay Networks," *IEEE Trans. Wireless Commun.*, vol.10, pp.253–263, Jan. 2011.
- [6] K. Anwar and T. Matsumoto, "Very simple BICM-ID using repetition code and extended mapping with doped accumulator," *Wireless Pers. Commun.*, 2011. DOI: 10.1007/s11277-011-0397-1.
- [7] K. Anwar and T. Matsumoto, "Spatially concatenated coded with turbo equalization for correlated sources," *IEEE Trans. Signal Process.*, vol.60, no.10, pp.5572–5577, Oct. 2012.
- [8] L. Hanzo, T.H. Liew, and B.L. Yeap, *Turbo Coding, Turbo Equalisation and Space-time Coding for Transmission over Fading Channels*, John Wiley IEEE Press, 2002.
- [9] D. Zhao, A. Dauch, and T. Matsumoto, "BICM-ID using extended mapping and repetition code with irregular node degree allocation," *IEEE Vehicular Tech. Conf.-Spring*, Barcelona, Sept. 2009.
- [10] P.-S. Lu, V. Tervo, K. Anwar, and T. Matsumoto, "Low-complexity strategies for multiple access relaying," *Vehicular Technology Conference (VTC Spring)*, Hungary, May 2011.
- [11] R. Cristescu, B. Beferull-Lozano, and M. Vetterli, "Networked slepian-wolf: Theory, algorithm and scaling laws," *IEEE Trans. Inf. Theory*, vol.51, no.12, pp.4057–4073, Dec. 2005.



Meng Cheng received the B.Eng. degree in telecommunication engineering from Anhui University of Technology (AHUT), China, in 2009 and the M.Sc. in wireless communications with distinction, from the University of Southampton, UK, in 2010. Now he is pursuing the Ph.D. degree in Information Theory and Signal Processing Laboratory in Japan Advanced Institute of Science and Technology (JAIST), Japan. His research interests are optimal power allocation strategies on cooperative communications, based on Slepian-Wolf theorem.

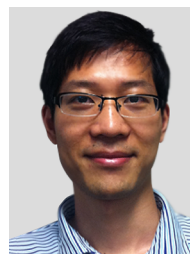

Xiaobo Zhou received the B.Sc. in Electronic Information Science and Technology from Univeristy of Science and Technology of China (USTC), Hefei, China in 2007 and the M.E. in Computer Application Technology from Graduate University of Chinese Academy of Sciences (GUCAS), Beijing, China, in 2010. He is currently working toward the Ph.D. degree in the School of Information Science, Japan Advanced Institute of Science and Technology (JAIST), Japan. His research interests include information theory, joint source-channel coding and cooperative wireless communications.



Khoirul Anwar graduated (*cum laude*) from the department of Electrical Engineering (Telecommunications), Institut Teknologi Bandung (ITB), Bandung, Indonesia in 2000. He received Master and Doctor Degrees from Graduate School of Information Science, Nara Institute of Science and Technology (NAIST) in 2005 and 2008, respectively. Since then, he has been appointed as an assistant professor in NAIST. He received best student paper award from the IEEE Radio and Wireless Symposium

2006 (RWS'06), California-USA, Best Paper of Indonesian Student Association (ISA 2007), Kyoto, Japan in 2007, and Award for Innovation, Congress of Indonesian Diaspora (CID), Los Angeles, USA, July 2012. Since September 2008, he is with the School of Information Science, Japan Advanced Institute of Science and Technology (JAIST) as an assistant professor. His research interests are network information theory, error control coding, iterative decoding and signal processing for wireless communications. He has authored around 63 scientific publications in these areas. He serves as a reviewer for a number of main journals and conferences in the area of wireless communications and signal processing. Dr. Anwar is a member of IEEE communication and information theory societies.



Tad Matsumoto received his B.S., M.S., and Ph.D. degrees from Keio University, Yokohama, Japan, in 1978, 1980, and 1991, respectively, all in electrical engineering. He joined Nippon Telegraph and Telephone Corporation (NTT) in April 1980. Since he engaged in NTT, he was involved in a lot of research and development projects, all for mobile wireless communications systems. In July 1992, he transferred to NTT DoCoMo, where he researched Code-Division Multiple-Access techniques for

Mobile Communication Systems. In April 1994, he transferred to NTT America, where he served as a Senior Technical Advisor of a joint project between NTT and NEXTEL Communications. In March 1996, he returned to NTT DoCoMo, where he served as a Head of the Radio Signal Processing Laboratory. In March 2002, he moved to University of Oulu, Finland, where he served as a Professor at Centre for Wireless Communications. In 2006, he served as a Visiting Professor at Ilmenau University of Technology, Ilmenau, Germany, funded by the German MERCATOR Visiting Professorship Program. In April 2007, he returned to Japan and since then he has been serving as a Professor at Japan Advanced Institute of Science and Technology (JAIST), while also keeping the position at University of Oulu. Prof. Matsumoto has been appointed as a Finland Distinguished Professor for a period from January 2008 thru December 2012, funded by the Finnish National Technology Agency (Tekes) and Finnish Academy, under which he preserves the rights to participate in and apply to European and Finnish national projects. Prof. Matsumoto is a recipient of IEEE VTS Outstanding Service Award (2001), Nokia Foundation Visiting Fellow Scholarship Award (2002), IEEE Japan Council Award for Distinguished Service to the Society (2006), IEEE Vehicular Technology Society James R. Evans Avant Garde Award (2006), and Thuringen State Research Award for Advanced Applied Science (2006), 2007 Best Paper Award of Institute of Electrical, Communication, and Information Engineers (IEICE) of Japan (2008), Telecom System Technology Award by the Telecommunications Advancement Foundation (2009), IEEE Communication Letters Exemplifying Reviewer Award (2011), and UK Royal Academy of Engineering Distinguished Visiting Fellow Award (2012). He is serving as an IEEE Vehicular Technology Distinguished Lecturer since July 2011. He is a Fellow of IEEE.