

Title	The Convex Configurations of “ Sei Shonagon Chie no Ita ” and Other Dissection Puzzles
Author(s)	Fox-Epstein, Eli; Uehara, Ryuhei
Citation	The 26th Canadian Conference on Computational Geometry (CCCG 2014): 386-389
Issue Date	2014-08
Type	Conference Paper
Text version	publisher
URL	http://hdl.handle.net/10119/14770
Rights	Copyright (C) 2014 Authors. Eli Fox-Epstein and Ryuhei Uehara, The 26th Canadian Conference on Computational Geometry (CCCG 2014), 2014, 386-389.
Description	



The Convex Configurations of “Sei Shōnagon Chie no Ita” and Other Dissection Puzzles

Eli Fox-Epstein*

Ryuhei Uehara†

Abstract

The *tangram* and *Sei Shōnagon Chie no Ita* are popular dissection puzzles consisting of seven pieces. Each puzzle can be formed by identifying edges from sixteen identical right isosceles triangles. It is known that the tangram can form 13 convex polygons. We show that *Sei Shōnagon Chie no Ita* can form 16 convex polygons, propose a new puzzle that can form 19, no 7 piece puzzle can form 20, and 11 pieces are necessary and sufficient to form all 20 polygons formable by 16 identical isosceles right triangles. Finally, we examine the number of convex polygons formable by different quantities of these triangles.

1 Introduction

A *dissection puzzle* is a game where one must decide whether a given set of polygons can be placed in the plane in such a way that their union is a given target polygon. Rotation and reflection are allowed but scaling is not, and all polygons must be internally disjoint. Formally, a set of polygons S can *form* a polygon P if there is an isomorphism up to rotation and reflection between a partition of P and the polygons of S (i.e. a bijection $f(\cdot)$ from a partition of P to S such that x and $f(x)$ are congruent for all x).

The *tangram* is a set of polygons consisting of a square cut by straight incisions into different-sized pieces. See the left diagram in Figure 1. Of anonymous origin, the first known reference in literature is from 1813 in China

*Brown University, USA, ef@cs.brown.edu

†School of Information Science, JAIST, Japan, uehara@jaist.ac.jp

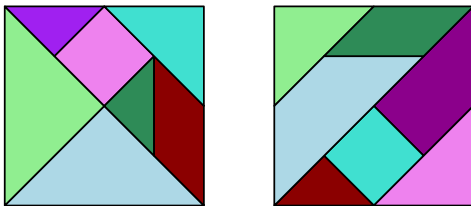

Figure 1: Left: the tangram in square configuration. Right: Sei Shōnagon Chie no Ita pieces in square configuration.



Figure 2: A set of plates in the form of Sei Shōnagon Chie no Ita pieces, crafted by Tomomi Takeda in Kanazawa, Japan.

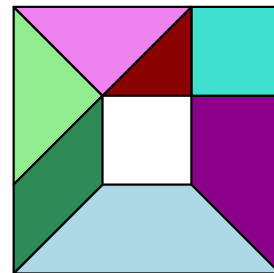

Figure 3: A typical Sei Shōnagon Chie no Ita layout as a square configuration with a hole missing.

[Slo04]. The tangram has grown to be extremely popular throughout the world and now has over 2000 dissection and related puzzles [Slo04, Gar87].

There is a similar but less famous Japanese set of puzzle pieces called *Sei Shōnagon Chie no Ita*. Sei Shōnagon was a courtier and famous novelist in Japan, but there is no evidence that the puzzle existed a millennium ago during her lifetime. *Chie no ita* means *wisdom plates*, which refers to the physical puzzle. It is said that the puzzle is named after Sei Shōnagon’s wisdom. Historically, the Sei Shōnagon Chie no Ita first appeared in literature in 1742 [Slo04]. Even in Japan, the tangram is more popular than Sei Shōnagon Chie no Ita, though Sei Shōnagon Chie no Ita is common

enough to have been made into ceramic dinner plates (see e.g. Figure 2, [Tak14]), and in puzzle communities it is admired for being able to form some more interesting shapes that the tangram cannot, such as a square configuration with a hole missing (Figure 3).

Wang and Hsiung considered the number of possible convex (filled) polygons formed by the tangram [WH42]. They first noted that, given sixteen identical isosceles right triangles, one can create the tangram pieces by gluing some edges together. Consequently, the tangram pieces can only form a subset of the convex polygons that sixteen identical isosceles right triangles can form. Embedded in the proof of their main theorem, Wang and Hsiung [WH42] demonstrate that sixteen identical isosceles right triangles can form exactly 20 convex polygons. These 20 are illustrated in Figure 7. The tangram can realize thirteen of them.

It is quite natural to ask how many of these convex polygons the Sei Shōnagon Chie no Ita pieces can form. We first show that Sei Shōnagon Chie no Ita achieves sixteen. Therefore, in a sense, we can conclude that Sei Shōnagon Chie no Ita is more expressive than the tangram: while both the tangram and Sei Shōnagon Chie no Ita contain seven pieces made from sixteen identical isosceles right triangles, Sei Shōnagon Chie no Ita can form more convex polygons than the tangram. (Also, recall that the Sei Shōnagon Chie no Ita configuration in Figure 3 is impossible with the tangram.)

One might next wonder if this can be improved with different shapes. We demonstrate a set of seven pieces that can form nineteen convex polygons among the 20 candidates, and that to realize them all, it is necessary to have at least eleven shapes, which is sufficient. Throughout, all triangles mentioned are identical isosceles right triangles with side lengths 1, 1, and $\sqrt{2}$.

2 The Sei Shōnagon Chie no Ita puzzle

Theorem 1 *The Sei Shōnagon Chie no Ita puzzle pieces can be rearranged into exactly sixteen distinct convex polygons up to reflection and rotation.*

Proof. We first notice that the seven puzzle pieces can be decomposed into sixteen identical right isosceles triangles, just like the tangram.

We make use of two important results from Wang and Hsiung [WH42]. First, there are only 20 candidate convex polygons that we need to consider; and second, in any formable convex polygon, the bases of the sixteen triangles can be pairwise collinear, parallel, or perpendicular ([WH42], Lemma 1). This means we only need to consider configurations that could be embedded with triangle and target polygon vertices on integer coordinates.

Sixteen convex polygons are filled as illustrated in Figure 8. The remaining four polygons cannot be

formed since they are too thin. More precisely, the largest trapezoid puzzle piece of area 2 has a base of length 3. Under the four rotations we need to consider, the base of the trapezoid does not fit into the target polygon. \square

3 An optimal seven piece puzzle

Although Sei Shōnagon Chie no Ita is more expressive than the tangram, Sei Shōnagon Chie no Ita is not the optimal set of seven pieces if one wishes to form as many convex polygons as possible.

Theorem 2 *There is a set of seven polygons composed from sixteen identical right isosceles triangles that can form nineteen distinct convex polygons. Furthermore, no set of seven polygons composed of sixteen identical right isosceles triangles can form 20 distinct convex polygons.*

Proof. The set of seven polygons that can form nineteen distinct convex polygons and its formations are depicted in Figure 9. Theorem 3 implies that no seven-piece puzzle can form all 20 convex polygons. \square

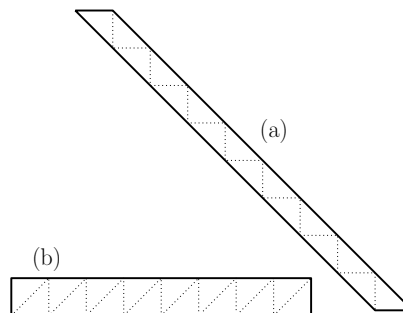

Figure 4: Any set of 7 pieces covering shape (a) must have a piece that consists of at least 3 triangles, which cannot be covered by shape (b).

4 Beyond seven pieces

The next natural question to ask is how many pieces built from sixteen identical isosceles right triangles might one need in order to form all 20 convex polygons.

Theorem 3 *Ten or fewer pieces formed from sixteen identical isosceles right triangles cannot form 20 convex polygons. However, eleven pieces can.*

Proof. In the negative direction, observe that to form the $1 \times 8\sqrt{2}$ parallelogram in Figure 4 (a) with ten pieces, there must be at least six $1 \times \sqrt{2}$ parallelograms and at most four single triangles (larger pieces all contain a

parallelogram and do not fit within the shape of Figure 4 (b)).

Consider the $2\sqrt{2}$ -sidelength square. The perimeter has 8 incident triangles, so the six parallelograms would have to cover at least four of those. Exhaustive case analysis, as seen in Figure 5, shows that all arrangements that cover enough of the exterior triangles leave a square in the middle and boundary triangles that cannot fit a single parallelogram.

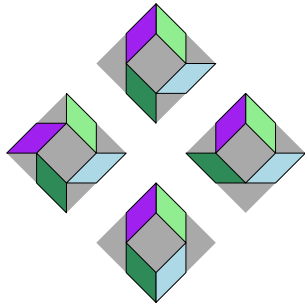

Figure 5: Six parallelograms do not fit in a square.

We observe that five $1 \times \sqrt{2}$ parallelograms can fit inside each of the 20 shapes: see Figure 10. So, these parallelograms along with six single triangles can realize all 20 convex polygons. \square

5 Concluding remarks

Sixteen identical right isosceles triangles can form twenty convex polygons. We compare the power of expression of some classic dissection puzzles constructed from these triangles. The “difficulty” of a dissection puzzle for people to solve can be estimated by the number of ways in which one can solve it. Computing these numbers efficiently remains a compelling task for future work.

Another interesting direction of study is the number of convex polygons formed by different numbers of triangles. Let $f(n)$ be the number of formable convex polygons formed by n identical right isosceles triangles. To analyze the tangram and Sei Shōnagon Chie no Ita puzzles, the value $f(16) = 20$ plays an important role. If we design larger puzzles, it is natural to consider the number of formable polygons. The function $f(n)$ itself is also interesting to investigate. The values of the function presented in Figure 6 were determined by computer search: all potential side length assignment to octogons were considered (for convex, simple arrangements of identical right isosceles triangles, the interior angles are at most $\frac{3\pi}{4}$; polygons with more than 8 sides have average exterior angle strictly less than $\pi/4$). Although it is not monotone ($f(1) = 1, f(2) = 3$, and $f(3) = 2$), it is a generally increasing function. Trivially, for all $x \geq 0$, we have $f(x) < f(2x)$ as one can subdivide

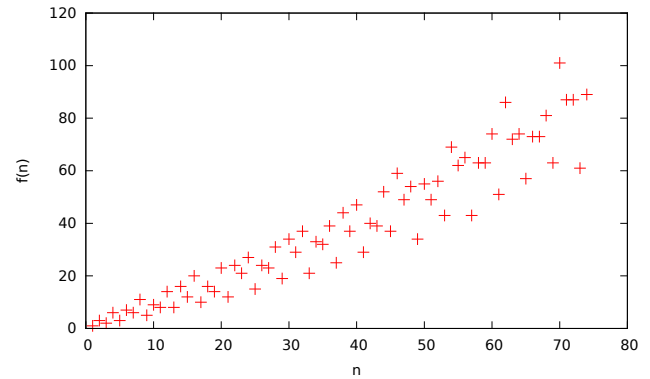

Figure 6: The number $f(n)$ of convex polygons formed by n identical right isosceles triangles.

every triangle into two to get the same number. The inequality’s strictness comes from a new, skinnier parallelogram with side lengths 1 and $x\sqrt{2}$.

Acknowledgements

We are especially grateful to the National Science Foundation’s East Asia and Pacific Summer Institutes and the Japan Society for the Promotion of Science Summer Program for encouraging international collaboration.

References

- [Gar87] Martin Gardner. *Time Travel and Other Mathematical Bewilderments*. W.H. Freeman & Company, 1987.
- [Slo04] Jerry Slocum. *The Tangram Book: The Story of the Chinese Puzzle with Over 2000 Puzzle to Solve*. Sterling Publishing, 2004.
- [Tak14] Tomomi Takeda. <http://www.matsusaki.jp/local-event/20140310/1024/>, March 2014. (in Japanese; accessed 8 May 2014).
- [WH42] Fu Traing Wang and Chuan-Chih Hsiung. A Theorem on the Tangram. *The American Mathematical Monthly*, 49(9):596–599, 1942.



Figure 7: All 20 potential convex polygons.

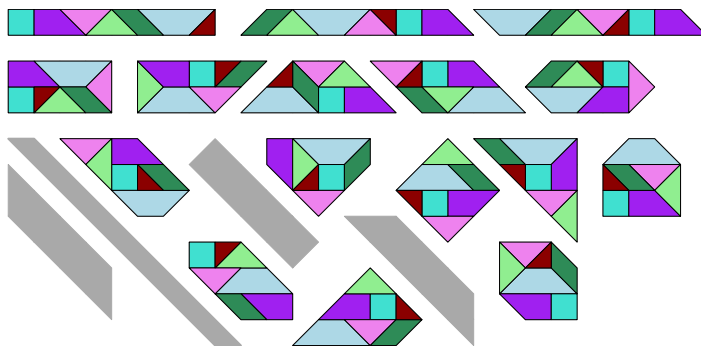

Figure 8: The sixteen convex polygons that can be formed by Sei Shōnagon Chie no Ita.

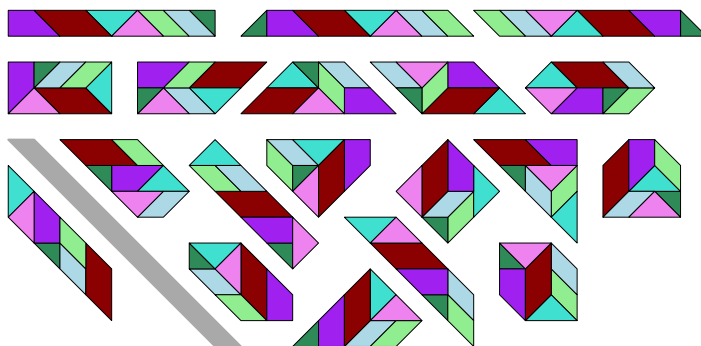

Figure 9: Seven pieces forming nineteen convex polygons.

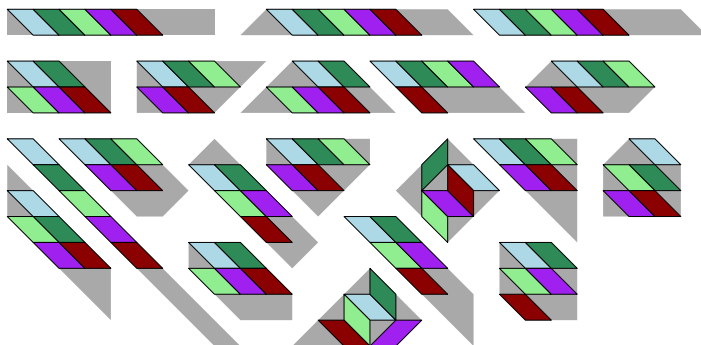

Figure 10: Eleven pieces forming all twenty convex polygons (the six individual isosceles right triangles not shown).