

Title	Low-latency communication in LTE and WiFi using spatial diversity and encoding redundancy
Author(s)	YU, Yu; KUCERA, Stepan; LIM, Yuto; TAN, Yasuo
Citation	IEICE Transactions on Communications, E101.B(4): 1116-1127
Issue Date	2018-04-01
Type	Journal Article
Text version	publisher
URL	http://hdl.handle.net/10119/15489
Rights	Copyright (C) 2018 The Institute of Electronics, Information and Communication Engineers (IEICE). Yu YU, Stepan KUCERA, Yuto LIM, and Yasuo TAN, IEICE Transactions on Communications, E101.B(4), 2018, 1116-1127. http://dx.doi.org/10.1587/transcom.2017EBP3015
Description	

PAPER

Low-Latency Communication in LTE and WiFi Using Spatial Diversity and Encoding Redundancy

Yu YU^{†a)}, Stepan KUCERA^{††}, *Nonmembers*, Yuto LIM[†], and Yasuo TAN[†], *Members*

SUMMARY In mobile and wireless networks, controlling data delivery latency is one of open problems due to the stochastic nature of wireless channels, which are inherently unreliable. This paper explores how the current best-effort throughput-oriented wireless services might evolve into latency-sensitive enablers of new mobile applications such as remote three-dimensional (3D) graphical rendering for interactive virtual/augmented-reality overlay. Assuming that the signal propagation delay and achievable throughput meet the standard latency requirements of the user application, we examine the idea of trading excess/federated bandwidth for the elimination of non-negligible delay of data re-ordering, caused by temporal transmission failures and buffer overflows. The general system design is based on (i) spatially diverse data delivery over multiple paths with uncorrelated outage likelihoods; and (ii) forward packet-loss protection (FPP), creating encoding redundancy for proactive recovery of intolerably delayed data without end-to-end retransmissions. Analysis and evaluation are based on traces of real life traffic, which is measured in live carrier-grade long term evolution (LTE) networks and campus WiFi networks, due to no such system/environment yet to verify the importance of spatial diversity and encoding redundancy. Analysis and evaluation reveal the seriousness of the latency problem and that the proposed FPP with spatial diversity and encoding redundancy can minimize the delay of re-ordering. Moreover, a novel FPP effectiveness coefficient is proposed to explicitly represent the effectiveness of FPP implementation.

key words: *forward packet-loss protection, data delivery latency control, spatial diversity, encoding redundancy, random linear codes, multi-path TCP*

1. Introduction

Nowadays, wireless networks and associated technologies are playing more important role in human daily life. Two frequently used wireless networks are cellular networks and wireless local area network (WLAN). On one hand, the first and second generations of cellular networks for mobile communications provided users with basic connectivity using analog and digital technology, respectively. The third generation networks, such as the code division multiple access (CDMA) based high speed packet access (HSPA) systems, enabled mobile Internet access in addition to wireless voice telephony. The fourth generation is represented by the current orthogonal frequency-division multiple access (OFDMA) based long term evolution (LTE) systems

that has emerged to be a true mobile broadband solution for heterogeneous traffic consisting of voice, video, and Internet data with higher deployment and maintenance costs. On the other hand, the WLAN specified by the Institute of Electrical and Electronics Engineers (IEEE) 802.11 protocol family (WiFi) is being deployed continuously. The 802.11 family consists of a series of half-duplex over-the-air modulation techniques that use the same basic protocol. 802.11-1997 was the first wireless networking standard in the family, but 802.11b was the first widely accepted one, followed by 802.11a, 802.11g, 802.11n, and 802.11ac. 802.11b and 802.11a works in the 2.4 GHz band with direct-sequence spread spectrum (DSSS) based transmission scheme and in the 5 GHz band with orthogonal frequency-division multiplexing (OFDM), respectively. 802.11g is the third modulation standard that works in the 2.4 GHz band with OFDM. 802.11n is an amendment that improves upon 802.11 standards by adding multiple-input multiple-output antennas (MIMO), operates on both the 2.4 GHz and the 5 GHz bands. The latest amendment is 802.11ac which supports wider channels in the 5 GHz band, more spatial streams, higher-order modulation, and the addition of Multi-user MIMO (MU-MIMO). Different to cellular networks, WiFi only provides excellent communication quality for users at low deployment costs in small coverage area.

Modern mobile devices, such as smart phones and tablets, already support multi-technology multi-band networking: they are commonly equipped with multiple LTE, WiFi transceivers operational in multiple licensed and unlicensed frequency bands. However, users only utilize one of the technologies at a time, either by user choice or by device control mechanisms. They have one aspect in common: best-effort data delivery, but without any quality of service (QoS) guaranteed by the network [1]. Opening gap between the growths of revenue and mobile data traffic [2], [3] brought general interest to enable new latency-sensitive applications such as steering and control of real and virtual objects (Tactile Internet), remote three-dimensional (3D) graphical rendering for virtual/augmented-reality overlay, remote traffic control of self-driving cars and drones, closed loop control of industrial processes, and gaming [4], [5]. To overcome these challenges, third generation partnership project (3GPP) radio access network (RAN) presented to the IEEE 802.11 wireless next generation standing committee, briefing them on the 3GPP work done in Rel-13 for LTE-WLAN aggregation (LWA) and LTE WLAN radio level in-

Manuscript received January 13, 2017.

Manuscript revised July 24, 2017.

Manuscript publicized September 29, 2017.

[†]The authors are with the School of Information Science, Japan Advanced Institute of Science and Technology (JAIST), Nomi-shi, 923-1211 Japan.

^{††}The author is a member of technical staff at Bell Laboratories, Nokia, Dublin, Ireland.

a) E-mail: yu.yu@jaist.ac.jp

DOI: 10.1587/transcom.2017EBP3015

tegration with IPsec tunnel (LWIP) [6]. For a user, LWA offers seamless usage of both LTE and WiFi networks and substantially increased performance. For a cellular operator, LWA simplifies WiFi deployment, improves system utilization, and reduces network operation and management costs. Yet, LWA is still under developing phase, and there is no real system/environment to evaluate these multi-path technologies. This research uses real life traffic to verify the significance of the spatial diversity. The real life traffic consists of three parts: LTE Macrocell (MC) data, LTE Small cell (SC) data, and WiFi data. In this research, the SC encompasses both femtocell and picocell.

Data transmission among wireless mobile devices via WiFi or LTE networks is handled by transport layer protocols and the most widely used is transmission control protocol (TCP). In fact, there are severe limitations on the performance of TCP usage over wireless networks. Assuming that the fundamental propagation delay of the infrastructure due to non-zero physical signal propagation and transmission duration is within the user application tolerance, the objective of this research is to define, formulate and investigate forward packet-loss protection (FPP) for minimizing delay of data re-ordering in the transport layer. A re-ordering event is defined as a time-wise contiguous sequence of out-of-order packets (not in-order packets) excluding any in-order packets (the sequence number is contiguous vary with time). Such events are caused by retransmissions after buffer overflows and failures of basic transmission processes (decoding, integrity checks, error recovery, and segment re-assembly). Moreover, our focus is precisely on LTE and WiFi networks, whose channel quality reporting targets the block error rate of 10% at the physical layer, thus implying a strong default dependence on retransmissions for error-free data transfer. The main scope of this paper is to propose the FPP and analyze the severity of the delay of re-ordering using the regular TCP to capture the real life traffic to verify the effectiveness of the proposed FPP. The integration of multi-path TCP and FPP is out of scope of this paper.

To the best of our knowledge, this is the first practical study of latency-sensitive services to use real LTE and WiFi data traffic traces. Examples of solutions for proprietary networks include [7], [8]. Within the domain of standardized systems, potential latency reduction gains assuming fundamental modifications of the LTE physical layer are studied in [9]. In the medium access, encoding redundancy is used to create novel LTE hybrid automatic repeat request (HARQ) mechanisms in [10]–[12]. On the network and transport layers, [13] examines opportunistic injections of encoded data into single-path WiFi transmissions. Novel TCP implementation using encoding redundancy principles with delayed block-level decoding is defined in [14]. A faster but difficult-to-configure scheme for proactive TCP retransmissions of unacknowledged data is discussed in [15].

The contributions of this paper are: (i) Yet there is no real system/environment to evaluate the multi-path technologies. This research initiated the harbinger by tracing

real life traffic to verify the importance of the spatial diversity and the encoding redundancy for low-latency communication; (ii) The severity of the delay imposed by re-ordering is intuitively understood by analyzing real life traffic; (iii) The proposed FPP thoroughly enables encoding redundancy for proactive recovery of intolerably delayed data without end-to-end retransmissions. With the spatial diversity, the FPP on secondary link minimizes the end-to-end retransmission overhead of the primary link. Moreover, FPP shows significant gain when buffer overflows are prevented; and (iv) The novel FPP effectiveness coefficient is proposed to explicitly represent the effectiveness of FPP implementation, which expressed in terms of a combination of spatial diversity and the variation of encoding redundancy with different audio and video requirements.

The paper organization can be summarized as follows. Section 2 briefly reviews the background and shows the motivation of the proposed encoding redundancy with spatial diversity. Section 3 presents the system architecture to minimize re-ordering delays in wireless links that considers forward packet-loss protection on the basis of random linear codes. The quantification of data re-ordering is summarized in Sect. 4. Here, the real life traffic traces of MC and SC networks in USA, and WiFi network in Japan are used for the quantitative analysis. The influence of spatial diversity and encoding redundancy are discussed in Sect. 5. Finally, Sect. 6 concludes this research work.

2. Background and Motivation

2.1 Background

Controlling data delivery latency is one of the open problems in mobile and wireless networks. Network latency is a term that is used to indicate any kind of delay that happens in data communication over a network, including propagation delay in the physical layer, queuing delay in the data link layer and the network layer, and delay of re-ordering in the transport layer. Propagation delay and queuing delay occur due to the limited speed of signal propagation and waiting time in limited buffer size, respectively. Compared to these delays that can be minimized through the hardware upgrade, the delay of re-ordering is the main issue that has to be minimized for latency-sensitive communication.

The end-to-end connection that encounters small delays, is called low-latency communication whereas connection that suffers long delay, is called high-latency communication. For low-latency communication, the end-to-end retransmission can lead to the unpredictable fluctuation in transmission rate, which is the phenomenon seriously affecting the quality of streaming of audio and/or video. For high-latency communication, the end-to-end transmitting time of a packet due to retransmission is extremely long because of hop count increment which can lead to very low end-to-end throughput.

2.2 Motivation

The traditional way to solve the end-to-end retransmission problem is either increasing the transmission rate or using the data aggregation technique to recover the lost or delayed packets instead of using retransmission mechanisms. Normally, increasing the transmission rate will increase the deployment cost, and using the data aggregation technique can result longer end-to-end retransmission when losing large packet sizes. With the spatial diversity, multiple radio access technologies in parallel can increase the network performance, but the delay of re-ordering and retransmission delay still occurs. Thus, FPP with spatial diversity and encoding redundancy is proposed in this research to effectively recover the delayed or lost packets instead of end-to-end retransmission. The proposed FPP is expected to provide more reliable and stable communication for low-latency communication.

3. System Architecture

Our approach to delay of re-ordering mitigation is based on two concepts – spatial diversity and encoding redundancy.

Spatial diversity refers to the delivery of a data flow over multiple radio access technologies in parallel, e.g., LWA, LWIP, etc. Hence, spatial diversity is to be understood in the transport-layer sense (YouTube video is downloaded simultaneously over LTE and WiFi whereby each wireless link represents an independent data delivery paths), not in the conventional physical-layer sense (e.g., antenna diversity of MIMO transmissions). The aggregation of multiple independent wireless links, or data delivery paths, into one logical connection theoretically allows increasing the overall throughput and reliability[†] as well as reducing latency by resource pooling – an advantageous feature when single-path connections cannot achieve the user demands. A new fifth-generation air interface as well as the allocation of new (shared) frequency bands can be expected in the near future [17], because of the global mobile data traffic will increase nearly eightfold between 2015 to 2020, from 3.7 exabyte (EB) to 30.6 EB per month [3]. Although the 4G (LTE system) has now been deployed and is reaching maturity, it is hard to meet the demands that network will face by 2020. The ongoing network densification by SC deployments improving the overall connectivity also clear motivates a study in this direction.

Encoding redundancy is one way to compensate for the unavoidable errors or outages of wireless links by injecting an additional protection data into the actual flow of payload data. In the latency control context, the idea is to establish FPP that allows recovering lost or unacceptably delayed payload data without retransmissions before an application-required delivery deadline expires. Retransmissions min-

imize overhead related to missing data recovery, but they also non-negligibly increase data delivery delay by at least 1.5× of the connection round-trip time, i.e., transmission-to-acknowledgement time, as well as cause throughput drop in protocols with loss-based congestion control, e.g., sliding window protocols. The simplest example of encoding redundancy consists of a primitive replication of a data flow over multiple parallel paths; techniques more efficient in terms of the overhead are discussed subsequently.

3.1 Bandwidth Aggregation

Single-path scenarios are considered as data re-ordering due to imperfect flow splitting and scheduling in multi-path scenarios can be efficiently solved assuming in-order delivery in each path [18]. Our approach to latency control of mobile user services over a primary wireless link is based on the idea of trading latency for federated/excess bandwidth. More specifically, it is assumed that an additional wireless interface of a mobile device is seamlessly allocated for simultaneous delivery of subsequently specified FPP data over an independent secondary link (see Fig. 1). The FPP data are used to recover lost or intolerably delayed payload data packets on the primary link before the user application can notice such events. Generalization of this atomic set-up of multiple links carrying payload and/or FPP data is straightforward. The multi-path scheduler is a source of an independent and therefore herein ignored delay of re-ordering.

It is therefore proposed to create the secondary link by using an additional wireless interface of the mobile device. As shown in Fig. 1, for dual connectivity and carrier aggregation, when LTE framework be implemented as the primary links, because of its changeable cell size from tens of meters radius (femto- and pico-cells) up to 100 km radius MCs; also lower latency for handover and connection set-up time, WiFi could be considered as the currently best option given its ubiquitous deployment, good performance, and free-of-charge access as the secondary link. Regarding link independence, it is to be noted that WiFi access points are often back-hauled via cellular networks, especially mobile WiFi in transport vehicles.

The radio interface management in mobile devices can be done by using the network-resident service that is demonstrated in [19]. This service makes central optimized decisions based on network-wide information and operator poli-

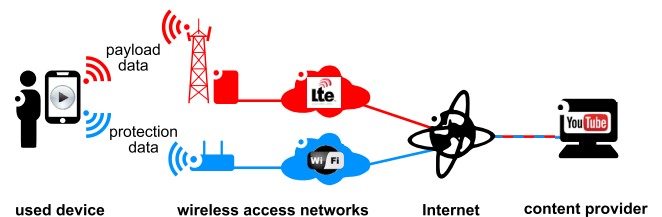

Fig. 1 Latency-sensitive LTE-based services (primary link) are protected by using parallel WiFi connection (secondary link) for delivering FPP data.

[†]Next-generation air interfaces may be prone to outages as the user body can efficiently block the propagation of the anticipated mm-wave carriers [16].

cies. Its implementation is based on the modified multi-path TCP (MPTCP), a backward compatible solution for seamless transport-layer integration of networking technologies that is standardized by the Internet Engineering Task Force (IETF) [20]. Although the MPTCP working group reported five independent implementations [21], the integration of MPTCP and the proposed FPP is out of scope of this paper. It can be recognized as an extension to the work after the verification of effectiveness of the proposed FPP.

3.2 Forward Packet-Loss Protection (FPP)

A naive way of protecting payload data consists of their replication over L , which is defined as the number of parallel links. The fastest link determines the overall latency at the expense of $(L - 1)$ -fold overhead. To compress the overhead to more reasonable levels, it is proposed to construct each FPP packet as a weighted random linear combination of n payload packets by using binary exclusive or (XOR) operation [22]. The multiplicative weights are selected at random in an identical, independent, and uniform manner [23].

Figure 2 visualizes the simplest protection scheme under which m FPP packets are generated for each n consecutive payload packets. In Fig. 2, $m = 1$ and $n = 3$. As depicted by Fig. 3, the decoding of a payload packet missing by a data delivery deadline can be done in real-time by using the received generator packets and Gaussian elimination [22], [23]. If the combining weights ensure maximum rank of the Gaussian system, one FPP packet can be used to recover one missing payload data packet or a part thereof. Thus, the protection percentage (ζ) defines the encoding protection strength of FPP, i.e.,

$$\zeta = \frac{m}{n} \times 100\% \quad (1)$$

e.g., $\zeta = 33\%$ in Fig. 2. Assuming that the link quality of primary link and secondary link is the same. When $\zeta = 0\%$, this means that FPP on the secondary link is not applied.

From a system point of view, one could require the protection data rate not to exceed the payload data rate, i.e., $m/n \leq 1$, as payload data duplication occurs for $\zeta = 100\%$. Yet in general, the instability of basic link characteristics such as effective throughput, delay jitter, and cross-traffic volume may justify a more complex design based on adaptive joint scheduling of FPP and payload data without an a priori primary/secondary characterization [18] but multipath scheduling issues are out of scope of this research contribution.

Besides the ζ factor, FPP also depends on the link quality of the primary link and secondary link. Hence, the link percentage (ρ) defines the percentage of effective transmission rate in between the secondary link (R_{sec}) and the primary link (R_{pri}), i.e.,

$$\rho = \frac{R_{sec}}{R_{pri}} \times 100\% \quad (2)$$

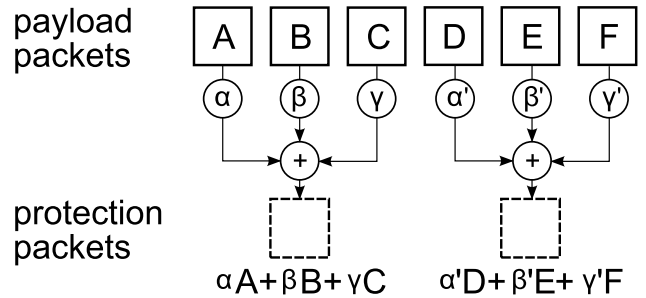

Fig. 2 Formation of FPP packets using random linear codes.

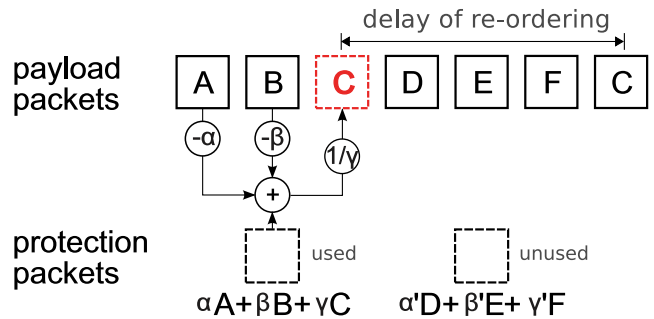

Fig. 3 Recovery of a delayed payload packet using FPP packets to avoid the delay of re-ordering. The first FPP packet is used due to payload packet 'C' is out-of-order, second FPP packet is unused due to payload packets are in-order.

If the FPP is applied, the link quality of the secondary link cannot be zero, i.e., $R_{sec} \neq 0$. When $\rho = 100\%$, this means that the link quality of secondary link and primary link are the same.

Since FPP is depending on two factors, i.e., ζ and ρ , the FPP effectiveness coefficient (FE) is used to indicate the effective range of the FPP implementation. It is defined as

$$FE = \frac{\zeta}{\rho} \quad (3)$$

where $\rho \neq 0$. FPP effectiveness coefficient can range from 0 to ∞ . An effectiveness of 1 ($FE = 1$) corresponds to a complete data duplication of the FPP. An effectiveness of 0 ($FE = 0$) indicates that the FPP is not applied, whereas an effectiveness more than 1 ($FE > 1$) represents that the FPP is not appropriately implemented. Essentially, the range of $0 < FE \leq 1$ indicates that the FPP is appropriately implemented.

The above description implicitly assumes protection against data loss or delay at the transport layer of the open systems interconnection (OSI) model, typically accommodating the connection-oriented TCP and the connection-less user datagram protocol (UDP). Accordingly, random linear combinations of TCP/UDP packets are sent as the secondary FPP information, and used by the receiver for recovery of data before they are passed on to the TCP/UDP modules.

Encoding protection can be implemented to lower OSI layers as well. The advantage consists in smaller size of FPP packets and earlier correction of errors, but only shorter

components of the overall end-to-end delay can be eliminated. Higher-layer errors would not be detectable nor correctable.

4. Quantification of Data Re-Ordering

This section describes the frequency and length of payload data re-orderings as well as the size of affected data blocks as measured in both LTE and WiFi networks. The trade off between the ζ of a secondary link and the achievable reduction of delay of re-ordering at the primary link is analyzed subsequently.

4.1 Definition

The following definitions that visualized in Fig. 4 are used to capture the frequently complex re-ordering events.

Let P, T and S indicate packet, time and sequence number respectively. Considering $P(T, S)$ is a TCP packet received in time T and carrying a range $S(T) = [S_1(T), S_2(T)]$ of TCP sequence numbers. For example, a given time t , $S_1(t)$ represents the first sequence number, and $S_2(t)$ represents the last sequence number. TCP sequence numbers indicate individual bytes of ordered payload data. Packets arrive in unique times and each sequence number is received only once.

1. In-order

A packet $P(T, S)$ is in-order if and only if (i) no sequence number higher than $S_2(T)$ has been received until time T (i.e., no packets expected after time T have been received); and (ii) $\cup_{\forall t < T} \arg_s P(t, s) = [1, S_1(T) - 1]$ the union of sequence numbers of all previously received packets is a contiguous range, (i.e., no packets expected before time T are missing).

2. Out-of-order

A packet $P(T, S)$ is out-of-order if it is not in-order.

3. Re-ordering event

A re-ordering event is defined as a time-wise contiguous sequence of out-of-order packets excluding any in-order packets. As shown in Fig. 4, the re-ordering event starts from an in-order packet and ends with the next consecutive in-order packet. N is the total number of packets in the re-ordering event.

4. Ideal in-order delivery

Ideal in-order delivery refers to how packets would have been received if no re-ordering event happened (see Fig. 4). Given the re-ordering event characterized by a sequence $P(T^i, S^i) \forall i \in [1, \dots, N]$ of out-of-order packets, where $S^i(T^i) = [S_1^i(T^i), S_2^i(T^i)]$, the ideal in-order delivery is defined as a sequence of packets $P(T^i, S^i)$ that are received in the original times T^i , and have monotonically increasing sequence numbers from the set $\cup_{\forall i} S^i(T^i)$, i.e., $S_2^i(T^i) + 1 = S_1^{i+1}(T^{i+1}) \forall i \in [1, \dots, N - 1]$.

5. Delayed in-order delivery

Delayed in-order delivery is understood as a shift

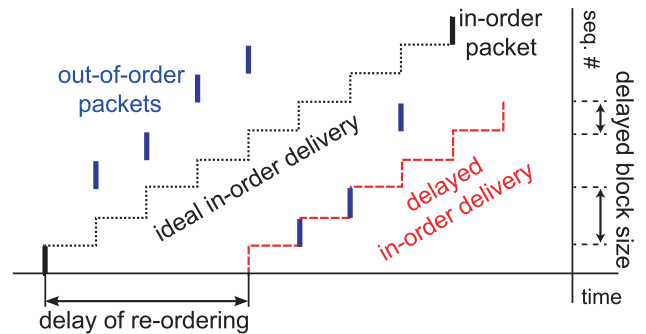

Fig. 4 Visualization of the characteristics of a re-ordering event.

of all ideally in-order delivered packets $P(T^i, S^i)$ in time by the corresponding delay D^i , i.e., a packet sequence $P(T^i + D^i, S^i) \forall i \in [1, \dots, N]$, where $S^i(T^i) = [S_1^i(T^i), S_2^i(T^i)]$.

6. Effectively lost

Assuming maximum tolerable delay D_{max} and $S^i = S^i$, an out-of-order packet $P(T^i, S^i)$ is effectively lost during the re-ordering event if the out-of-order packet $P(T^i, S^i)$ would have been received later than the corresponding packet $P(T^i + D_{max}, S^i)$ in the ideal in-order delivery sequence delayed by D_{max} , i.e., for given i , $\arg_{T^i} P(T^i, S^i) > \arg_{T^i} P(T^i + D_{max}, S^i)$.

4.2 Evaluation Metrics

The captured traffic traces are analyzed in terms of:

1. *Effective transmission rate (R)* – average effective transmission rate of each measured scenario. The effective transmission rate is calculated as the measured number of units of data divided by the measurement time.
2. *payload data rate (r)* – average physical data rate of the ideal in-order delivery sequence during the re-ordering event.
3. *delay of re-ordering (D_r)* – delay by which the ideal in-order delivery sequence $P(T^i + D^i, S^i)$ of a re-ordering event must be delayed such that none of the out-of-order packets is considered effectively lost, i.e.,

$$D_r = \arg_{D^i} \max_{i \in Q} [\arg_{T^i} P(T^i + D^i, S^i) - \arg_{T^i} P(T^i, S^i)] \quad (4)$$

for $S^i = S^i$ where Q is the set of out-of-order packets when $0 < D^i \leq D_{max}$, e.g., $Q = 3$ in Fig. 4.

4. *delayed block size (B_d)* – total number of out-of-order packets in bytes considered lost during a re-ordering event with respect to the ideal in-order delivery sequence ($D^i = 0$). It is the cardinality of the above set Q , i.e., $B_d = \sum_k B_k$, where $k \in Q$, B is the block size in bytes.

5. *average inter-event time separation* – average time interval between two consecutive re-ordering events. Assuming consecutively a limited resolution of the user in distinguishing consecutive events, multiple short re-ordering events occurring within a period of 100 ms are counted only as single event.

4.3 Measurement Data

4.3.1 LTE Network

LTE re-ordering events are quantified based on TCP data captured in live LTE networks from February to March 2015 in the New York city, USA. Two kinds of tools are used to capture real life mobile data, i.e., `tcpdump` on Ubuntu (14.04.3 LTS) and Wireshark on Microsoft Windows 7. `tcpdump` is a free and common packet analyzer that runs under the command line. Wireshark is a free and open source packet analyzer that is used for network troubleshooting, analysis, software and communications protocol development. Two devices that are installed with Ubuntu and Microsoft Windows 7, respectively act as file transfer protocol (FTP) clients. One more device that is installed with Ubuntu acts as a FTP remote server. Four LTE universal serial bus (USB) modems LG VL600, Qualcomm 9630, LG G7, Huawei e3276s-150 are used in the data collocation with regular TCP. The default TCP CUBIC implementation, an optimized congestion control algorithm for high bandwidth networks with high latency, is used for the Ubuntu-based device. Repetitive large data transfers of 0.1~1 gigabyte (GB) are used to emulate long-lived sessions. As a result, extensive traffic traces at the order of tens of GB are obtained in the following two scenarios:

- MC scenarios (*cross mark in the following graphs*)
Downlink only (DL): Test user equipment (UE) connects over a commercial MC network (AT&T Inc.) of a major carrier to a remote server from both outdoor and indoor locations to download data using FTP. The server is located in the physical proximity to the LTE public gateway to avoid traffic passing through the Internet. Two sub-scenarios are distinguished: (i) *Unlimited* – background download traffic is low to moderate (off-peak hours in outdoor location). (ii) *Limited* – the data rate is an operator-limited, which is 10% of the possible data rate. Background download traffic is high (peak-hour in indoor location).
- SC scenarios (*circle mark in the following graphs*)
Downlink/Uplink (DL/UL): Test UEs for indoor environment connect over a carrier-grade SC network in a large private enterprise network to a server to download/upload data. The server connects directly to the LTE public gateway, which is located at the enterprise site. Background traffic is low to moderate and the service LTE data rate is unlimited. Two sub-scenarios are distinguished: (i) *Static* – UEs are static. (ii) *Handovers* – UEs are moving and at least one (typically

multiple) handovers occur during each session. UEs move at slow to fast walking speeds.

4.3.2 WiFi Network

WiFi re-ordering events are quantified based on regular TCP data captured from 3rd to 15th October 2015 at Japan Advanced Institute of Science and Technology (JAIST), Japan. For WiFi access points (APs), Cisco Aironet 1252 and 3702i are used, which support with 802.11n only and both 802.11n and 802.11ac, respectively. Two devices act as FTP clients, one is Ubuntu (15.04) with `tcpdump`, and another is Mac OS X (10.11) with Wireshark. The server based on Ubuntu (15.04) directly connects with APs through Ethernet. The distance between APs is quite different due to their location in the buildings, the average distance of APs is about 23 meters. Both download and upload data is about 5 GB. Extensive traffic traces about 35 GB are obtained in the following scenarios:

- WiFi scenarios (*triangle mark in the following graphs*)
Downlink/Uplink (DL/UL): 76 DL scenarios for both indoor and outdoor environments and 44 UL scenarios for only indoor environment with different distance from APs are traced. Two sub-scenarios are distinguished: (i) *Static* – UEs are static. (ii) *Handovers* – UEs move at normal walking speed. For DL, at least 4 APs handovers (roaming) are occurred. For UL more than 2 APs handovers are occurred.

4.4 Data Analysis

In this research, it is important to note that packet losses can occur anywhere in the network and at any layer. Physical layer losses of the LTE radio link can be mostly (but not always) recovered by using Hybrid ARQ (HARQ) mechanisms in the media access control (MAC) and radio link control (RLC) layer of the LTE protocol stack. Yet buffer overflows can occur anywhere along the connections and can only be recovered by transport-layer retransmissions, resulting the re-ordering event happened at the receiver side and associated with their delays. The measurement scenarios are uncooperative, e.g., UE is either “static” or “handover”. In our measurements, TCP is focused. It carries roughly 80% of Internet traffic and relies on explicit flow and congestion control in order to reduce the probability of data loss due to the congestion losses.

All of the captured real life traffic traces are analyzed under Ubuntu (15.04). The processing procedures are as follows:

1. Use `tcptrace`[†] to produce several different types of output containing information on each measurement scenario, such as elapsed time, bytes, sequence number and round trip times.

[†]O., Shawn, [Online]. Available: <http://www.tcptrace.org/>.

Table 1 Statistical measurement results of each scenario.

Scenarios			Effective Transmission Rate (Mbps)		Inter-event Time Separation (s)		Delay of Re-ordering (s)	
			mean	σ	mean	σ	mean	σ
MC	DL	Unlimited	4.54	2.25	34.01	69.26	1.13	4.47
		Limited	0.39	0.18	78.88	69.30	12.84	30.21
SC	DL	Static	21.39	11.06	7.02	10.03	0.30	0.36
		Handovers	30.85	12.30	10.90	18.18	0.26	0.56
WiFi	DL	Static	41.46	44.85	3.60	4.27	0.04	0.06
		Handovers	34.79	33.19	1.35	1.30	0.26	1.48
SC	UL	Static	9.65	5.43	1.84	0.83	0.09	0.18
		Handovers	12.37	4.85	16.68	20.64	0.23	0.17
WiFi	UL	Static	141.14	28.40	26.60	28.11	0.05	0.01
		Handovers	55.38	17.00	23.75	40.15	6.65	6.36

2. Use `xplot.org` command to plot the figures of `tcptrace` output files, confirm the correctness.
3. If `tcptrace` output files are correct, treat them as input files to the original MATLAB program to output the results of Sect. 4.2.

Through the data analysis, the TCP maximum transmission unit (MTU) is also calculated, i.e., 1388 bytes in LTE networks, and from 1280 to 1420 bytes (average value is 1378 bytes) in different scenarios of WiFi. All of the measurement results (i.e., MC, SC and WiFi) are drew in the same graphs in Sect. 4.5 because there is no much gap difference in the TCP MTU size (i.e., $1388 - 1378 = 10$ bytes). Since both LTE and WiFi data rate are in Megabits per second (Mbps), thus the said gap difference is negligible.

4.5 Measurement Results

The statistical measurement results of each scenario are presented in Table 1, including average effective transmission rate, average time between two consecutive re-ordering events, average delay of re-ordering and their standard deviation (σ), respectively. A cumulative distribution functions (CDF) of measured payload data rate, delay of re-ordering, and delayed block sizes for each scenario are shown in Figs. 5, 6 and 7, respectively.

A wide range of data rates are used for the measurements. For WiFi, IEEE 802.11n (maximum data rate is 300 Mbps) and IEEE 802.11ac (maximum data rate is 1300 Mbps) based APs are used. For LTE, maximum data rate is close to 300 Mbps for SC, and only 150 Mbps for MC. The results of average effective transmission rate in Table 1 also confirm the reliability of the measured data. Here, the σ of effective transmission rate on “WiFi DL Static” is large due to using IEEE 802.11n or 802.11ac traces as “WiFi” scenarios. Table 1 presents that high average effective transmission rate implies more frequent re-ordering events happening in DL scenarios. Especially in SC/WiFi, the re-ordering event time separation is reduced to only a few seconds, and the delay of re-ordering is not as serious as MC DL scenarios, which can be easily recovered with the proposed FPP. With limited effective transmission rate, MC DL scenarios have longer inter-event time separation, but also have intolerably delay of re-ordering. Although WiFi handover sce-

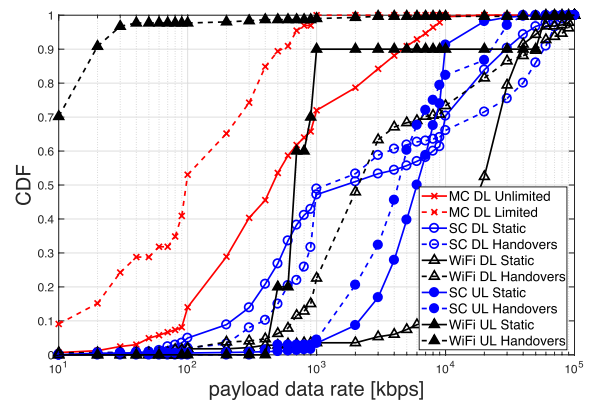
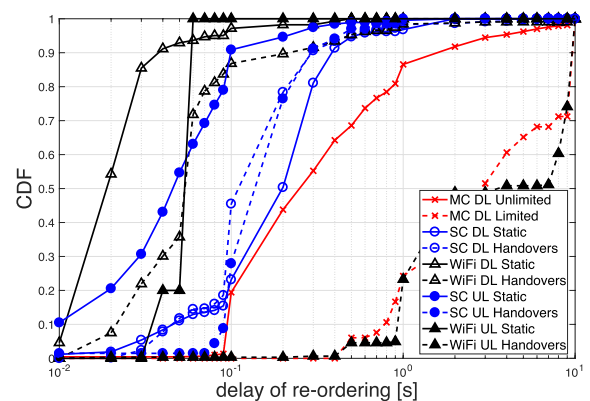
**Fig. 5** Cumulative distribution function of payload data rate.**Fig. 6** Cumulative distribution function of delay of data re-ordering.

narios have great effective transmission rate, the delay of re-ordering is much worse than in static scenarios. The σ results of delay of re-ordering obviously indicate how serious the problem of re-ordering event.

As we can observe from Fig. 5 to Fig. 7, the lines are crossed with each others and their performances of data transmission are randomly changed. The main reasons for these phenomena are that the effective transmission rates of each scenario are different and how the TCP mechanism works during the data measurements. From Fig. 5, it can be seen that the overall payload data rate of the 4 scenarios (“WiFi UL Handovers”, “MC DL Limited”, “WiFi

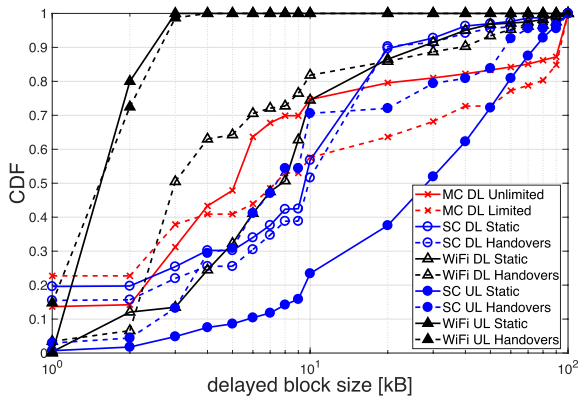

Fig. 7 Cumulative distribution function of delayed data block sizes.

UL Static”, and “MC DL Unlimited”) is less than 1 Mbps. The corresponding payload of the other 6 scenarios are all greater than 1 Mbps. The fastest one is the “WiFi DL Static”, which has 80% more than 10 Mbps, and the lowest one is the “WiFi UL Handovers”, which has 90% less than 0.02 Mbps. The results of MC scenarios indicate that by reducing the DL payload data rate to approximately 10% of the achievable payload data rate (“MC DL Unlimited” vs “MC DL Limited”), the re-ordering event period reduces from 79 s to 34 s, while the delay of re-ordering reduces by almost 10-times. Thus, if the re-ordering delay can be minimized by the proposed FPP, the effective transmission rate would be further improved.

It can be seen in Fig. 6 that most of the scenarios have less than 400 ms overall delay of re-ordering, and only “MC DL Limited” and “WiFi UL Handovers” have intolerable delay of re-ordering (more than 70% worse than 1 s). Thus, referring to Fig. 5, it can be observed that high payload data rate normally leads low delay of re-ordering. E.g., “WiFi DL Static” has the highest payload data rate, it has the lowest delay of re-ordering. If the intolerable delay is set to 100 ms (audio level), all SC scenarios except “SC UL Static” cannot meet the requirement, which can be easily solved in Sect. 5 with FPP. SC DL/UL handovers have low impact on the overall payload data rate but cause major delay of re-ordering increase. The “WiFi DL Handovers” has low delay of re-ordering due to most of the out-of-order packets has efficient lost during its bad connection period. The “WiFi UL Static” also has the same situation because of less out-of-order packets (packets are in-order with long delay caused by retransmission).

Figure 7 indicates that the delayed data block size (monotonically increasing and often overlapping) refers to random, no matter with payload data rate and delay of re-ordering. Both “WiFi UL Static” and “WiFi UL Handovers” have less delayed block size than other scenarios due to either packets are in-order packets with long delay (retransmission) or out-of-order packets are efficiently lost. Left-bottom part of Fig. 7 indicates that effective losses of few packets that could be attributed to the failures of the physical/data link layers[†] account only 5-20% of all losses in all

studied scenarios. Such small effective losses can be easily recovered by using low constant-rate of ζ . However, more typical losses of tens of packets either require a relatively high effective ζ for payload data recovery or simply make effective data recovery impossible.

In summary, it is observed that low average payload data rate implies less frequently re-ordering events happen, but characterized by generally serious delay of re-ordering. Small effective losses can be easily recovered by using FPP with low constant-rate of ζ . Large-scale of out-of-order packets during a re-ordering event are caused by buffer overflows, which require a relatively high effective ζ for payload data recovery. Analysis also indicates that most of them are caused by the TCP congestion control algorithm. Due to the serious delay of re-ordering and frequent re-ordering events from the measurement results, it is necessary to eliminate or minimize the non-negligible delay of re-ordering.

5. Influence of Spatial Diversity and Encoding Redundancy

In this section, the influence of encoding redundancy and spatial diversity is analyzed to mitigate the delay of re-ordering, which means the influence of protection percentage (ζ) and link percentage (ρ) to delay of re-ordering.

5.1 Influence of Protection Percentage

The influence between ζ and primary link delay of re-ordering consists in the fact that the replication of primary link data to the secondary link ($\zeta = 100\%$) minimizes the delay of re-ordering, while no FPP ($\zeta = 0\%$) implies inactive latency control. In this subsection, ρ is set to 100% to show the influence of ζ only, which means there is no influence on the effective transmission rate of the secondary link. Since $\rho = 100\%$, the FE is equal to ζ . E.g., $\zeta = 100\%$ leads to $FE = 1$, which corresponds to a complete data duplication of the FPP.

To examine how data streams benefit from the FPP, let examine a scheme with a given constant ζ that attempts to recover all the effectively lost packets during each re-ordering event. More accurately, a reduced delay in second (D_{min}) is computed as the minimum of (i) the delay of re-ordering D_r experienced during a re-ordering event; and (ii) time needed for the delivery of FPP data size, which equals to the delayed data block size (B_d) given a payload data rate (r) of ζ , i.e., as

$$D_{min} = \min \left(D_r, \frac{B_d}{(\zeta/100 \cdot r)} \right) \tag{5}$$

where $\zeta/100 \cdot r$ can be defined either as a relative fraction of the payload data rate experienced during the re-ordering event (Fig. 8), or in absolute terms (Fig. 9). Using payload

[†]LTE coding and modulation for average signal-to-interference-and-noise ratio allows transmitting thousand of bits over several units of LTE resource block.

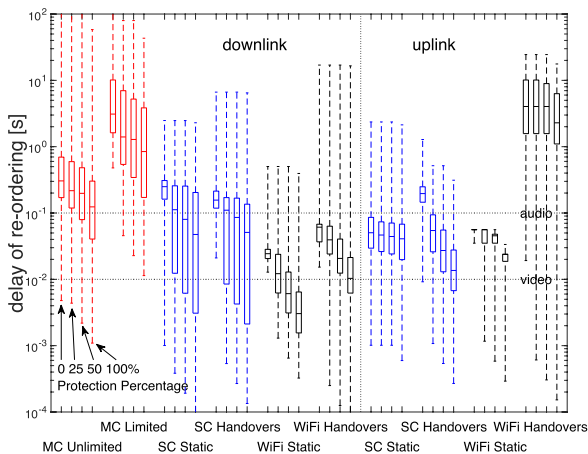

Fig. 8 Distribution of delay of data re-ordering as function of ζ being a pre-defined fraction of the physical payload data rate. Range bars delimit the 25-th and 75-th percentiles as well as indicate the median.

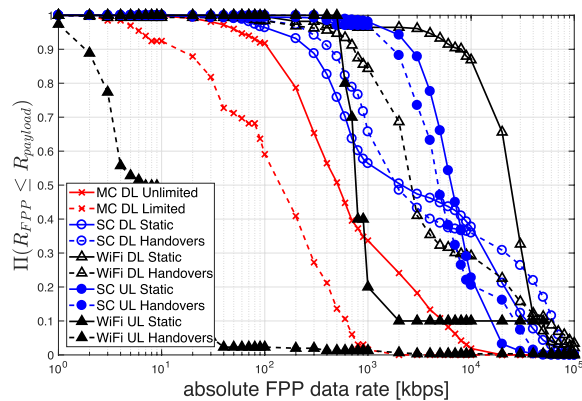

Fig. 9 Probability that the ζ data rate of the secondary link is lower than the payload data rate of the primary link.

data rate instead of the effective transmission rate is more accurate due to the TCP's fluctuation in transmission rate.

It is observed from Fig. 8 that scenarios characterized by low physical data rate (both “MC DL Unlimited/Limited” and “WiFi UL Handovers” scenarios) or short delay of re-ordering (“SC UL Static” and “WiFi UL Static”) do not benefit from FPP. In the former case, FPP is not sufficiently available due to limited data rate of ζ , while in the latter case, reductions of delay of re-ordering in already short delay of re-ordering are negligible. The rest (SC DL scenarios, WiFi DL scenarios and “SC UL Handovers”) exhibit the right balance of sufficiently high data rate and long-enough delay of re-ordering that makes the impact of FPP the most significant.

The benefits of FPP could be clearly enhanced by improving the data rate of the ζ . In this context, Fig. 9 shows the probability that the FPP data rate of the secondary link is lower than the payload data rate of the primary link. Nevertheless, the notion of primary and secondary link should be revisited when high relative ζ is required (comparable data rate of primary and secondary links). Let alone when the

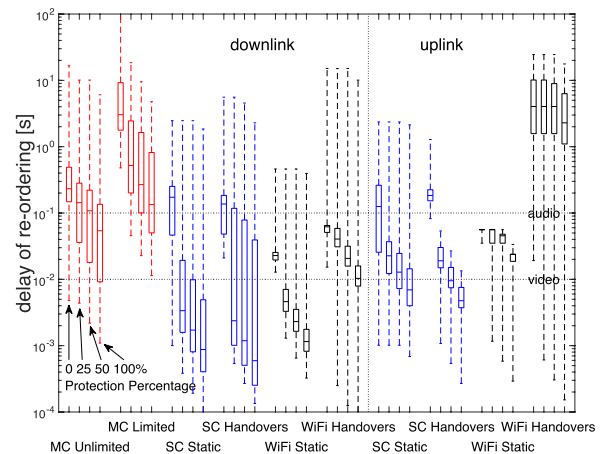

Fig. 10 Distribution of delay of data re-ordering as function of constant-rate FPP from 8, assuming prevention of TCP buffer overflows. Range bars delimit the 25-th and 75-th percentiles as well as indicate the median.

secondary effective transmission rate exceeds the primary one in this subsection.

We observe from right-top part of Fig. 7 that large-scale of out-of-order packets in LTE network can be explained by the “Unacknowledged RLC Mode” which permits to drop unacknowledged data during a handover. Although it was not possible to confirm the RLC configuration in the measured commercial networks, it can be generally stated that this mode is used for broadcast over multicast control channel (MCCH) and multicast traffic channel (MTCH) using multimedia broadcast multicast service single frequency network (MBSFN) or for voice over internet protocol (VoIP). The more common TCP/IP traffic is typically handled in the RLC “Acknowledged Mode” under which unacknowledged packets are forwarded from the source E-UTRAN node B (eNodeB) to the target eNodeB to ensure in collaboration with the LTE packet data convergence protocol (PDCP) layer an in-order non-duplicate data delivery processing even during handovers.

Traces of eNodeB ingress and egress traffic show that large-scale of out-of-order packets during a re-ordering event are actually caused by buffer overflows in the LTE base stations (BSs). More specifically, loss-based mechanisms for TCP congestion control systematically cause buffer overflows by progressively increasing sending data rate to detect the available channel capacity under rapidly fluctuating networking conditions.

Figure 10 shows that preventing buffer overflows caused by the transport layer, e.g., by using delay-based congestion control as known from TCP Vegas or TCP Compound, the effectiveness of FPP-driven recovery from unavoidable data losses within the protocol stack is substantially better compared to the case with uncontrolled overflows from Fig. 8. In particular, we observe that substantially lower ζ allows achieving major reductions of delay of re-ordering, achieving an order of magnitude in SC networks rather than WiFi networks.

From Table 1 average inter-event time separation, ev-

Table 2 *FE* performance for the combination of spatial diversity with audio and video requirements.

Primary Link	Secondary Link	R_{pri} (Mbps)	R_{sec} (Mbps)	ρ (%)	FE_{audio}	FE_{video}
WiFi DL Static	WiFi DL Static	41.46	41.46	100.00	0.03	0.27
	SC DL Static		21.39	51.60	0.05	0.53
	MC DL Unlimited		4.54	10.94	0.25	2.51
	MC DL Limited		0.39	0.95	2.88	28.83
SC DL Static	WiFi DL Static	21.39	41.46	193.81	0.03	0.28
	SC DL Static		21.39	100.00	0.05	0.55
	MC DL Unlimited		4.54	21.20	0.26	2.58
	MC DL Limited		0.39	1.84	2.97	29.66

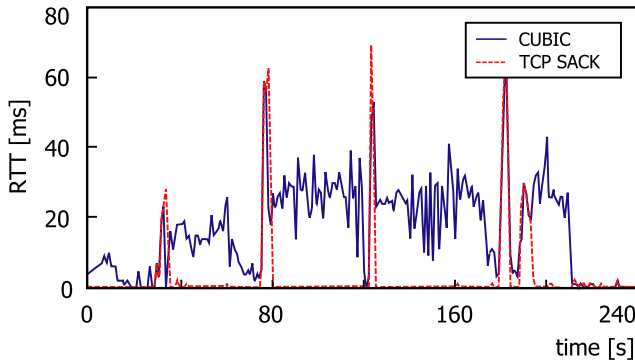
**Fig. 11** Correlation of round-trip time (RTT) under default CUBIC with re-ordering events as indicated by TCP Selective Acknowledgments (SACK) (“SC DL Static”).

idence can be created by depicting the correlation between buffer overflow times, indicated by TCP Selective Acknowledgment (SACK) of out-of-order data, and round-trip time build-up under default CUBIC, a quantity directly proportional to queue occupancy in private queues typical for LTE and WiFi, e.g., see Fig. 11. Note that in such queues, cross-traffic cannot directly contribute to buffer occupancy or delay; it only affects the serving data rate.

5.2 Influence of Link Percentage

In this subsection, the influence of link percentage (ρ) is discussed. The standard latency requirements (*SLR*) of the audio and video are 100 ms and 10 ms, respectively. Four DL scenarios are selected out from the measurement data to be analyzed in pairs. “WiFi DL Static”, “SC DL Static”, “MC DL Unlimited”, and “MC DL Limited” are selected due to the significant contrast between them. From the quantitative analysis results of Sect. 4.5, we observe that “WiFi DL Static” has the lowest influence when re-ordering event occurs. Thus, it is the best choice as the primary link to analyze the influence of ρ . “SC DL Static” is selected as the primary link for comparative analysis. For the secondary link, the combination of the two scenarios; “MC DL Unlimited” and “MC DL Limited” show the influence of ρ on *FE* clearly. Since *SLR* of audio or video is set, ζ is found to vary with the primary link quality, i.e., $\zeta = \frac{B_i/SLR}{R_{Pri}} \times 100\%$, where B_i/SLR is the necessary effective transmission rate for FPP. The analysis results are listed in Table 2.

The value of *FE* determines whether the FPP on the

secondary link is appropriately implemented or not. Table 2 indicates that the *FE* is inversely proportional to the ρ accordingly to the secondary link quality. For example, when “WiFi DL Static” acts as the primary link, “MC DL” acts as the secondary link, when the ρ of “MC DL Unlimited” is high, the *FE* is low and vice versa for the “MC DL Limited.” FPP *FE* can be enhanced by increasing ρ or the quality of secondary link. Moreover, if $\rho > 100\%$, which means using high quality link as the protection link, the *FE* will be quite small, although it is a waste of network resources. That is the case when “SC DL Static” that is protected by the “WiFi DL Static” is compared to “WiFi DL Static” that is protected by the “WiFi DL Static.” Low *SLR* requires high FPP *FE*, e.g., video. As we mentioned in Sect. 4.5, the data traffic under IEEE 802.11n/ac is traced for WiFi analysis, the performance is much greater than the normal situation by using IEEE 802.11b/g, which is unstable especially in public areas. As the secondary link, the performance of normal WiFi can be considered as similar to the analysis results of “MC DL Unlimited” and “MC DL Limited”.

5.3 Discussion

In summary, FPP exhibits the right balance of sufficiently high data rate and long-enough delay of re-ordering to proactively recover intolerably delayed data without end-to-end retransmission. FPP with adaptive-rate scheme enhances itself proactively in anticipation of major data losses must be generally coupled with rate adaptation in the transport layer, the ζ can be minimized and the FPP performance maximized (low-latency). The effectiveness of FPP also could be clearly enhanced by improving the effective transmission rate of its implemented link, i.e., secondary link in this research. Another way is that depicting the correlation between buffer overflow times by TCP selective acknowledgement and round-trip time. Moreover, the novel FPP (*FE*) is proposed to explicitly represent the effectiveness of FPP implementation. The value of *FE* directly indicates whether the FPP is appropriately implemented or not. Also, how to efficiently use the secondary link will be the extension work of this paper, it will be discussed on the implementation in MPTCP environment.

For low-latency communication, the proposed FPP reduces the fluctuation of retransmission delay when packet loss occurs due to buffer overflow or transmission failures. As a result, the proposed FPP would stabilize the effective

transmission rate. Moreover, for high-latency communication, the end-to-end transmitting time of a packet due to retransmission is extremely long because of the hop count increment. In that case, the FPP can significantly increase the end-to-end throughput.

6. Conclusion

The networking scenario in which payload data are delivered over a primary link while protection data are delivered in parallel over a secondary link has been discussed. The protection data is used to mitigate delay of re-ordering of the payload data without the need for lengthy reactive retransmission. Its main design characteristic is the combination of spatially diversity multi-path data delivery with redundant FPP based on random linear codes. Extensive measurements of live carrier-grade LTE networks in the New York city, targeting both SC and MC scenario deployments, and WiFi scenarios in Japan are collected for detailed performance analysis. Results revealed that the most notable reductions in delay of re-ordering are observed in SC networks. It is also shown that the transport layer largely determines the ζ versus delay of re-ordering trade off. The necessity of cross-layer design with transport layer is realized as TCP-caused buffer overflows unnecessarily degrade the achievable latency performance. FPP in combination with buffer overflow prevention, e.g., via delay-based congestion control, is proposed to achieve even order-of-magnitude reductions of delay of re-ordering for low ζ . Also, by the novel FPP *FE*, the effectiveness of FPP implementation can be explicitly represented.

Future works include the following parts: (i) In this research, processing of encoding time is not considered in the FPP due to the slight effect, this will be considered in the follow research to improve the precision of FPP performance; (ii) The FPP will be implemented and verified in MPTCP environment, and the integration between FPP and MPTCP will be discussed for the enhancement of network performance; (iii) The FPP can be implemented on both primary and secondary links, which can offer substantially increased performance (high throughput, low latency, etc.). It depends on the development of new specifications, e.g., LWA. The design of an intelligent switching mechanism based on the latency constraint or an adaptive data rate interaction algorithm between payload and protection packets is necessary for this direction; and (iv) The evolution of TCP SACK number based on average inter-event time separation is also one of the attractive extension of this research.

Acknowledgements

The author would like to thank to NOKIA Bell Labs for giving him the opportunity to internship as a researcher, also thank to Dr. Milind Buddhikot for his technical expertise and dedicated support.

References

- [1] 3GPP Work Item Description, "SI: Study on latency reduction techniques for LTE," 3GPP TSG RAN Meeting #67, Technical Report, RP-150465, March 2015. [Online]. Available: <http://www.3gpp.org/DynaReport/TDocExMtg-RP-67-31196.htm>
- [2] GSMA, "The mobile economy 2015," Technical Report, 2015. [Online]. Available: <http://www.gsamobileeconomy.com/GSMA-Global-Mobile-Economy-report-2015.pdf>
- [3] Cisco, "Cisco visual networking index: Global mobile data traffic forecast update, 2015–2020 white paper," Technical Report, 2016. [Online]. Available: <http://www.cisco.com/c/en/us/solutions/collateral/service-provider/visual-networking-index-vni/mobile-white-paper-c11-5208.62.html>
- [4] N. Nikaiein, R. Knopp, A.M. Cipriano, S. Krco, I. Tomic, P. Svoboda, M. Laner, E. Larsson, Y. Wu, M.G. Fuertes, J. Banos, N. Zeljkovic, and D. Marovic, "Low-latency in wireless communication," Proc. Vitel, pp.93–99, Slovenia, April 2011.
- [5] G.P. Fettweis, "The tactile internet: Applications and challenges," IEEE Veh. Technol. Mag., vol.9, no.1, pp.64–70, March 2014.
- [6] 3GPP, "Collaboration on LTE-WLAN intergration," Technical Report, 2016. [Online]. Available: <http://www.3gpp.org/news-events/3gpp-news/1771-wlan.lte>
- [7] D. Szabo, A. Gulyas, F.H. Fitzek, and D.E. Lucani, "Towards the tactile Internet: Decreasing communication latency with network coding and software defined networking," Proc. IEEE European Wireless Conf., pp.1–6, Budapest, Hungary, May 2015.
- [8] M. Weiner, M. Jorgovanovic, A. Sahai, and B. Nikolic, "Design of a low-latency, high-reliability wireless communication system for control applications," Proc. IEEE Int. Conf. on Commun. (ICC), pp.3829–3835, Sydney, Australia, June 2014.
- [9] Ericsson, "LTE latency improvement gains," Technical Report, 2014. [Online]. Available: <http://www.ericsson.com/research-blog/lte/lte-latency-improvement-gains>
- [10] D. Vukobratovic, C. Khirallah, V. Stankovic, and J.S. Thompson, "Random network coding for multimedia delivery services in LTE/LTE-Advanced," IEEE Trans. Multimedia, vol.16, no.1, pp.277–282, Jan. 2014.
- [11] Z. Lv, K. Xu, and Y. Xu, "A practical HARQ scheme with network coding for LTE-A broadcasting system," Proc. IEEE Conf. on Wireless Commun. and Signal Process. (WCSP), pp.1–6, Huangshan, China, Oct. 2012.
- [12] H. Hamdoun, P. Loskot, and T. O'Farrell, "Implementation trade-offs of fountain codes in LTE and LTE-A," Proc. IEEE Conf. on Commun. and Netw. (CHINACOM), pp.419–424, Kunming, China, Aug. 2012.
- [13] R. Mahajan, J. Padhye, S. Agarwal, and B. Zill, "High performance vehicular connectivity with opportunistic erasure coding," Proc. Conf. on USENIX Annu. Tech. Conf. (ATC), pp.237–248, Bostn, USA, Jun. 2012.
- [14] Y. Cui, L. Wang, X. Wang, H. Wang, and Y. Wang, "FMTCP: A fountain code-based multipath transmission control protocol," IEEE/ACM Trans. Netw., vol.23, no.2, pp.465–478, Jan. 2015.
- [15] C. Paasch, Improving multipath TCP, Ph.D. thesis, UC Louvain, Nov. 2014.
- [16] C. Gustafson and F. Tufvesson, "Characterization of 60 GHz shadowing by human bodies and simple phantoms," Proc. IEEE Europ. Conf. on Antennas and Propagation (EUCAP), pp.473–477, Prague, Czech Republic, March 2012.
- [17] 4G Americas, "5G spectrum recommendations," Technical Report, 2015. [Online]. Available: <http://www.4gamericas.org/en/resources/white-papers>
- [18] A.G. Saavedra, M. Karzand, and D.J. Leith, "Low delay random linear coding and scheduling over multiple interfaces," Aug. 2015. [Online]. Available: <http://arxiv.org/abs/1507.08499>
- [19] L. Hartung and M. Milind, "Policy driven multi-band spectrum ag-

gregation for ultra-broadband wireless networks,” Proc. IEEE Dynamic Spectrum Access Networks (DySPAN), pp.82–93, Stockholm, Sweden, Sept. 2015.

- [20] A. Ford, C. Raiciu, M.J. Handley, O. Bonaventure, and C. Paasch, “RFC 6824: TCP extensions for multipath operation with multiple addresses,” IETF, Jan. 2016. [Online]. Available: <https://tools.ietf.org/html/draft-ietf-mptcp-rfc6824bis-05>.
- [21] P. Eardley, “Survey of MPTCP implementations,” Internet-Draft draft-eardley-mptcp-implementations-survey-02, IETF, July 2013. Work in Progress.
- [22] S. Katti, H. Rahul, W. Hu, D. Katabi, M. Médard, and J. Crowcroft, “XORs in the air: Practical wireless network coding,” IEEE/ACM Trans. Netw., vol.16, no.3, pp.497–510, May 2008.
- [23] M. Karzand, D.J. Leith, J. Cloud, and M. Medard, “Low delay random linear coding over a stream,” Oct. 2015. [Online]. Available: <http://arxiv.org/abs/1509.00167>



Yu Yu received his B.Eng. degree in Computer Science and Technology from the Xi’an University of Science and Technology in 2009. He received his M.S. degree in Information Science from the Japan Advanced Institute of Science and Technology (JAIST) in 2014. Now he is a Ph.D. student in JAIST. His research interests include multihop wireless networks, heterogeneous wireless networks, and wireless interference management.



Stepan Kucera received the M.Sc. degree in communications and radio engineering from Czech Technical University, Prague, Czech Republic, in 2003, and the Ph.D. degree in informatics from the Kyoto University, Kyoto, Japan, in 2008. He is currently with Bell Laboratories, Nokia, Dublin, Ireland. Between 2008 and 2011, he worked as a Researcher with the National Institute for Telecommunications and Communications, Keihanna Research Laboratories, Kyoto, Japan. He holds multiple patents related to 3G and 4G mobile networks. Dr. Kucera is the recipient of the Best Student Paper Award at the IEEE Vehicular Technology Conference Fall 2006 and the IEEE Kansai Student Researcher Encouragement Award in 2007. He was nominated for the IEICE Young Researcher Encouragement Award in 2009 and the Ericsson Young Scientist Award in 2010. He is a member of the IEEE.



Yuto Lim received the B.Eng. (Hons) and M.Inf. Technology degrees from Universiti Malaysia Sarawak (UNIMAS), Malaysia in 1998 and 2000, respectively. He received the Ph.D. degree in communications and computer engineering from Kyoto University in 2005. He was a visiting researcher at Fudan University in China for two months. During 2005–2009, he was an expert researcher at National Institute of Information and Communications Technology (NICT), Japan. Since 2009, he has been working at Japan Advanced Institute of Science and Technology (JAIST) as an associate professor. His research interests include multihop wireless networks, wireless sensor networks, home networks, wireless mesh networks, heterogeneous wireless networks, network coding, cyber-physical system. He is a member of IEEE, IEICE and IPSJ.



Yasuo Tan received his Ph.D. from Tokyo Institute of Technology in 1993. He joined Japan Advanced Institute of Science and Technology (JAIST) as an assistant professor of the School of Information Science in 1993. He has been a professor since 1997. He is interested in Ubiquitous Computing System especially Home Networking Systems. He is a leader of Residential ICT SWG of New Generation Network Forum, a chairman of Green Grid Platform at Home Alliance, an advisory fellow of ECHONET Consortium, and a member of IEEE, ACM, IPSJ, IEICE, IEEEJ, JSSST and JNNS.